

PEL 115



Power energy logger

Thank you for purchasing a **PEL115 power and energy logger**.

For best results from your instrument:

- **read** these operating instructions carefully,
- **comply** with the precautions for use.



WARNING, risk of DANGER! The operator must refer to these instructions whenever this danger symbol appears.



WARNING! Risk of electric shock. The voltage on the parts marked with this symbol may be dangerous.



Equipment protected by double insulation.



Earth.



USB socket.



Ethernet socket (RJ45).



SD Card.



Main power supply input.



Useful information or tip to read.



The product has been declared recyclable after analysis of its life cycle in accordance with the ISO14040 standard.



The CE marking indicates compliance with the European Low Voltage Directive (2014/35/EU), Electromagnetic Compatibility Directive (2014/30/EU), Radio Equipment Directive (2014/53/EU), and Restriction of Hazardous Substances Directive (RoHS, 2011/65/EU and 2015/863/EU).



The UKCA marking certifies that the product is compliant with the requirements that apply in the United Kingdom, in particular as regards Low-Voltage Safety, Electromagnetic Compatibility, and the Restriction of Hazardous Substances.



The rubbish bin with lines through it indicates that, in the European Union, the product must undergo selective disposal in compliance with Directive WEEE 2012/19/EU. This equipment must not be treated as household waste.

CONTENTS

1. FIRST USE	6
1.1. Delivery condition	6
1.2. Accessories	7
1.3. SPARE PARTS	7
2. PRESENTATION OF THE INSTRUMENT	8
2.1. Description.....	8
2.2. Front panel	9
2.3. Terminal block.....	10
2.4. Installation of the coloured inserts	10
2.5. Functions of the keys.....	11
2.6. LCD display unit	11
2.7. Indicators	12
2.8. Memory card.....	13
3. CONFIGURATION	14
3.1. Switching the instrument on and off	14
3.2. Battery charging	15
3.3. Connection by USB or by Ethernet LAN link	15
3.4. Connection by Wi-Fi link.....	16
3.5. Configuring the instrument	17
3.6. Information.....	20
4. USE	23
4.1. Distribution networks and connections of the PEL	23
4.2. Recording	30
4.3. Measured-value display modes.....	30
5. SOFTWARE AND APPLICATION	50
5.1. PEL Transfer software	50
5.2. PEL application	51
6. TECHNICAL CHARACTERISTICS	53
6.1. Reference conditions.....	53
6.2. Electrical characteristics	53
6.3. Communication.....	63
6.4. Power supply	63
6.5. Mechanical characteristics	63
6.6. Environmental characteristics.....	64
6.7. Electrical safety	64
6.8. Electromagnetic compatibility	64
6.9. Radio emission	64
6.10. Memory card.....	64
7. MAINTENANCE	66
7.1. Cleaning	66
7.2. Battery	66
7.3. Updating the embedded software.....	66
8. WARRANTY	67
9. APPENDIX	68
9.1. Measurements.....	68
9.2. Measurement formulas	70
9.3. Electrical networks allowed	73
9.4. Quantity according to the distribution network.....	75
9.5. Glossary	78

Definitions of the measurement categories

- Measurement category IV (CAT IV) corresponds to measurements taken at the source of low-voltage installations.
Example: power feeders, meters and protection devices.
- Measurement category III (CAT III) corresponds to measurements on building installations.
Example: distribution panel, circuit-breakers, machines or fixed industrial devices.
- Measurement category II (CAT II) corresponds to measurements taken on circuits directly connected to low-voltage installations.
Example: power supply to domestic electrical appliances and portable tools.

Example to identify the locations of measurement categories

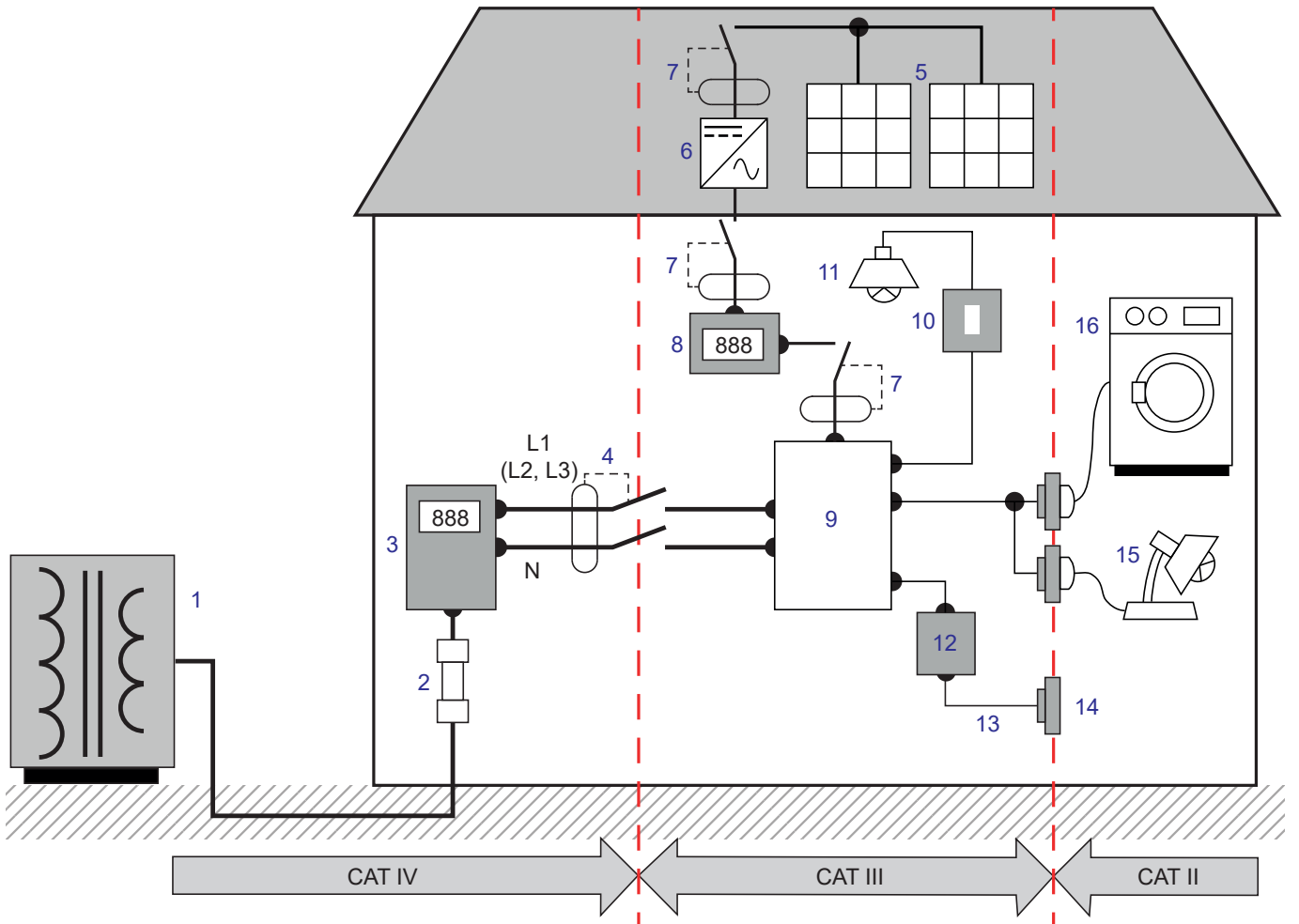

- | | |
|--|---|
| 1 Low-voltage supply source over or under ground | 9 Distribution board |
| 2 Service fuse | 10 Light switch |
| 3 Tariff meter | 11 Lighting |
| 4 Mains circuit breaker or isolator switch * | 12 Junction box |
| 5 Photovoltaic panel | 13 Socket wiring |
| 6 DC to AC inverter | 14 Socket outlets |
| 7 Circuit breaker or isolator switch | 15 Plug-in lamps |
| 8 Generation meter | 16 Household appliances, portable tools |

* : The mains circuit breaker or isolator switch may be installed by the service provider. If not, the demarcation point between CAT IV and CAT III is the first isolating switch in the distribution board.

PRECAUTIONS FOR USE

This instrument complies with safety standard IEC/EN 61010-2-030 or BS EN 61010-2-030, the leads comply with IEC/EN 61010-031 or BS EN 61010-031 for voltages of 1000 V in measurement category IV and the current sensors comply with IEC/EN 61010-2-032 or BS EN 61010-2-032.

Failure to observe the safety instructions may result in electric shock, fire, explosion, or destruction of the instrument and of the installations.

- The operator and/or the responsible authority must carefully read and clearly understand the various precautions to be taken in use. Sound knowledge and a keen awareness of electrical hazards are essential when using this instrument.
- Use only the supplied or specified accessories (voltage leads, current sensors, mains adaptor, etc.).
 - When assembling an instrument with leads, crocodile clips or mains adaptor, the nominal voltage for a single measurement category is the lowest of the nominal voltages assigned to the individual components.
 - When connecting a current sensor to a measuring instrument, account must be taken of any potential feedback of voltage from the measuring instrument to the current sensor and therefore of the common mode voltage and acceptable measurement category at the current sensor secondary.
- Before each use, check the condition of the insulation on the leads, housing, and accessories. Any item of which the insulation is deteriorated (even partially) must be set aside for repair or scrapping.
- Do not use the instrument on networks of which the voltage or category exceeds those mentioned.
- Do not use the instrument if it seems to be damaged, incomplete, or poorly closed.
- Use only the mains power unit supplied by the manufacturer.
- Use personal protection equipment systematically.
- When handling the leads, test probes, and crocodile clips, keep your fingers behind the physical guard.
- If the instrument is wet, dry it before connecting it.
- The instrument cannot be used to verify the absence of voltage in a network. For that, use the appropriate tool (a VAT) before doing any work on the installation.
- All troubleshooting and metrological checks must be performed by competent and accredited personnel.

1. FIRST USE

1.1. DELIVERY CONDITION

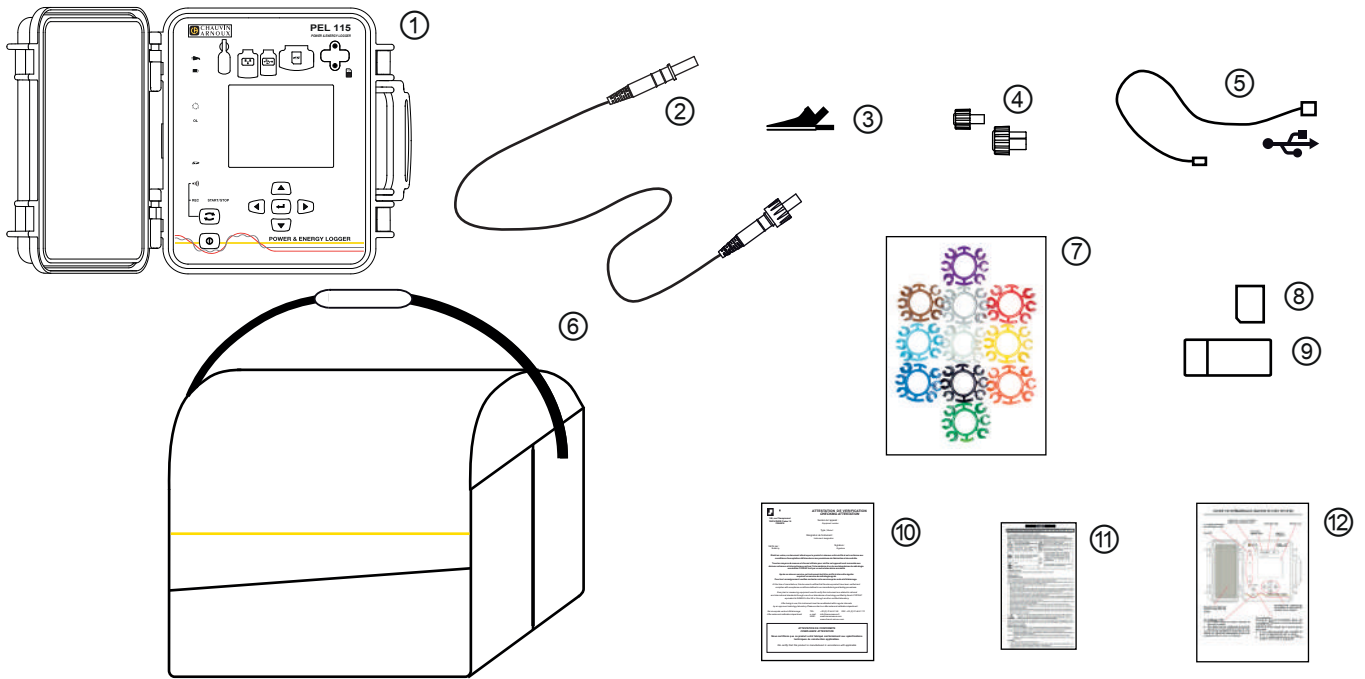

Figure 1

No.	Designation	Quantity
①	PEL115.	1
②	Black safety leads, 3m, banana-banana, straight-straight, tight and lockable.	5
③	Lockable black crocodile clips.	5
④	Tight plugs for the terminals (mounted on the instrument).	9
⑤	USB cord, type A-B, 1.5m.	1
⑥	Carrying case.	1
⑦	Set of inserts and rings used to identify the phases on the measurement leads and on the current sensors.	12
⑧	8GB SD card (in the instrument).	1
⑨	SD card-USB adapter.	1
⑩	Certificate of verification.	1
⑪	Multilingual safety data sheet.	1
⑫	Getting started guide.	13

Table 1

1.2. ACCESSORIES

- MiniFlex MA194 250 mm
- MiniFlex MA194 350 mm
- MiniFlex MA194 1000 mm
- MiniFlex MA196 350 mm tight
- AmpFlex® A193 450 mm
- AmpFlex® A193 800 mm
- AmpFlex® A196 610 mm tight
- MN93 clamp
- MN93A clamp
- C193 clamp
- PAC93 clamp
- E94 clamp
- J93 clamp
- 5A adapter (three-phase)
- Essailec® 5A adapter
- DataView software
- Magnetic test probes
- PEL mains adapter PA30W



The weight exerted by the measuring leads may cause the magnetic test probes to come loose. We advise you to support them by securing them to the electrical installation. This can be, for example, by a magnetic cable clamp or cable reel.

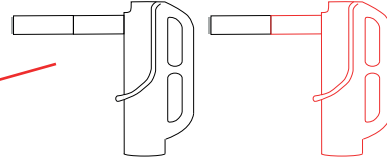

Pole attachment kit

Cord reel

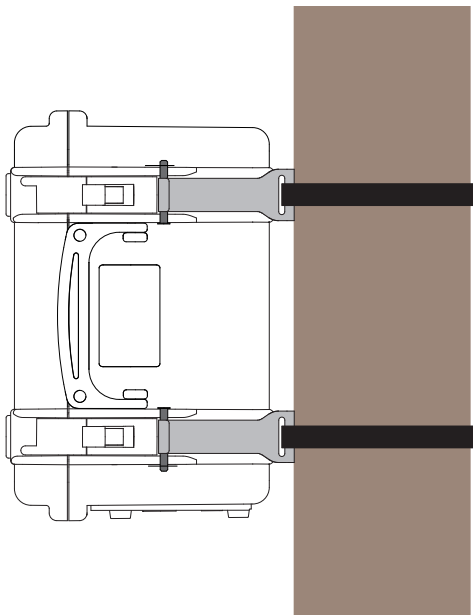

Figure 2

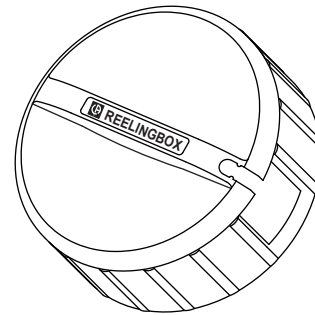

Figure 3

1.3. SPARE PARTS

- Set of 5 black safety cables, banana-banana straight-straight, 3m long, tight and lockable.
- Set of 5 lockable crocodile clips.
- AmpFlex® A196A 610 mm tight
- USB-A - USB-B cord
- No. 23 carrying case
- Set of 5 black safety cables, banana-banana straight-straight, 5 crocodile clips, and 12 phase identification inserts and rings for the voltage leads and the current sensors.

For accessories and spares, visit our web site:

www.chauvin-arnoux.com

2. PRESENTATION OF THE INSTRUMENT

2.1. DESCRIPTION

PEL: Power & Energy Logger (power and energy logger)

The PEL115 is a DC, single-phase, two-phase, and three-phase (wye and Δ) power and energy logger in a rugged sealed housing.

The PEL has all power/energy recording functions needed for most of the world's 50Hz, 60Hz, 400Hz, and DC distribution networks, with many connection possibilities to suit different installations. It is designed to operate in 1,000V CAT IV environments, both indoors and out.

The PEL has a battery with which to continue to operate if there is a power outage. The battery is recharged during the measurements.

The instrument has the following functions:

- Direct measurements of voltages up to 1,000V CAT IV.
- Direct measurements of currents from 5mA to 10,000A depending on the current sensors.
- Measurements of the neutral current on the 4th current terminal.
- Measurements of the voltage between earth and neutral on the 5th voltage terminal.
- Measurements of active power (W), reactive power (var), and apparent power (VA).
- Measurements of the fundamental, unbalance, and harmonic active powers.
- Measurement of current and voltage unbalances by the IEEE 1459 method.
- Measurements of active energy at source and load (Wh), 4-quadrant reactive energy (varh), and apparent energy (VAh).
- Power factor (PF), $\cos \varphi$ and $\tan \Phi$.
- Crest factor.
- Total harmonic distortion (THD) of voltages and currents.
- Voltage and current harmonics up to the 50th at 50/60Hz.
- Frequency measurements.
- Simultaneous RMS and DC measurements on each phase.
- LCD display unit with blue backlighting (simultaneous display of 4 quantities).
- Storage of measured and calculated values on SD or SDHC card.
- Automatic recognition of the various types of current sensor.
- Configuration of the transformation ratios for the current and voltage inputs.
- Management of 17 types of connection or power distribution networks.
- USB, LAN (Ethernet) and Wi-Fi communication.
- PEL Transfer software for data recovery, configuration, and real-time communication with a PC.
- Android application to communicate in real time and configure the PEL from a smartphone or a tablet.
- IRD server (DataViewSync™) to communicate using private IP addresses.
- Sending of periodic reports by email.

2.2. FRONT PANEL

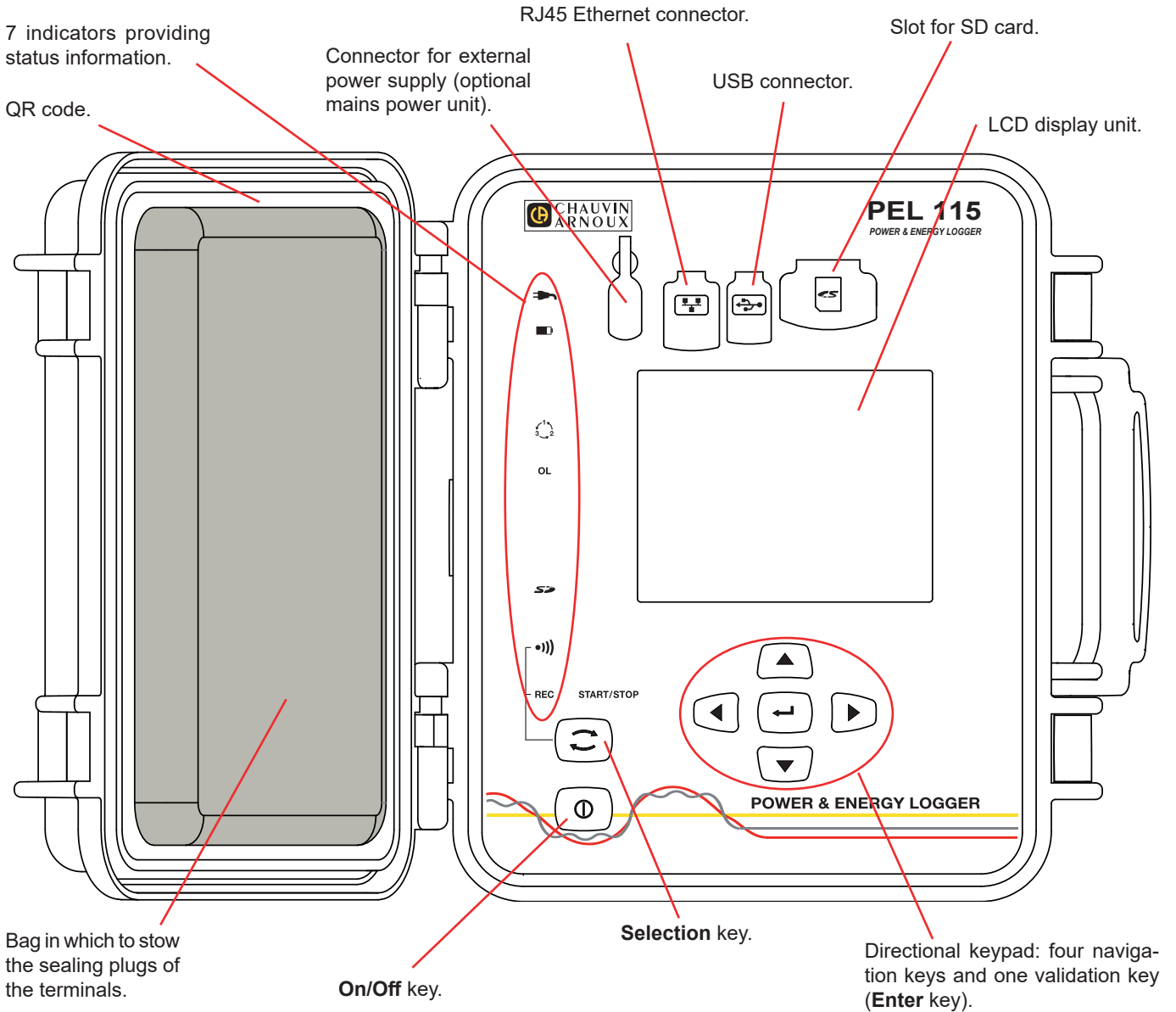
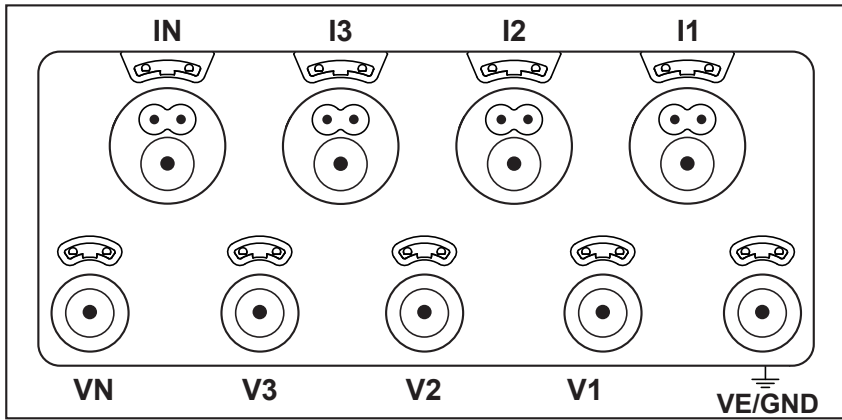

Figure 4

The connectors have elastomer caps that make them tight (IP67).

The mains power unit for recharging the battery is optional. It is not essential because the battery is recharged whenever the instrument is connected to mains (if supply via the voltage inputs has not been deactivated; see § 3.1.4).

2.3. TERMINAL BLOCK



4 current inputs (specific 4-point connectors).

5 voltage inputs (safety connectors).

Figure 5

The plugs keep the terminals tight (IP67) when they are not in use.

When you connect a current sensor or a voltage lead, screw it tight to keep the instrument tight. Stow the plugs in the bag attached to the cover of the instrument.

 Before connecting a current sensor, refer to its operating instructions.

The small holes above the terminals are for the insertion of the coloured inserts used to identify the current or voltage inputs.

2.4. INSTALLATION OF THE COLOURED INSERTS

For polyphase measurements, start by marking the accessories and terminals with the coloured rings and inserts provided with the instrument, assigning a different colour to each terminal.

- Detach the appropriate inserts and place them in the holes above the terminals (the large ones for the current terminals, the small ones for the voltage terminals).
- Clip a ring of the same colour to each end of the cord that will be connected to the terminal.

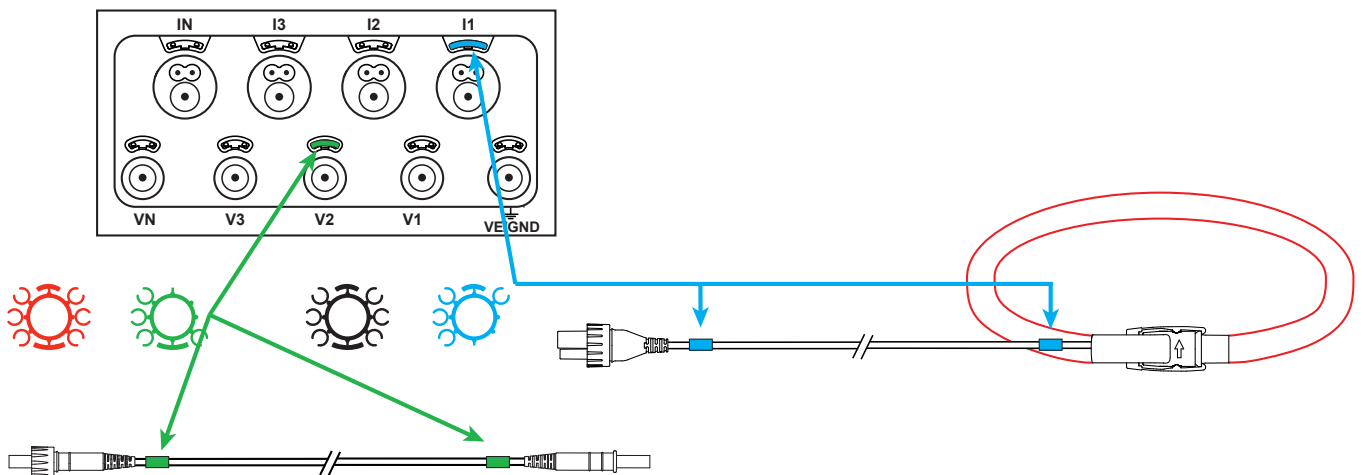

Figure 6

2.5. FUNCTIONS OF THE KEYS

Key	Description
	On/Off Key: Switches the instrument on or off. Remark: The instrument cannot be switched off when it is connected to mains (whether by the measurement inputs or by the mains power unit) or when recording is in progress or pending.
	Selection key: A long press activates or deactivates the Wi-Fi link and starts or stops recording.
	Enter key: In the Configuration mode, this is used to select a parameter to be changed. In the measurement and power display modes, it is used to display the phase angles and the partial energies.
	Navigation keys: These are used to browse the data displayed on the LCD screen.

Table 2

2.6. LCD DISPLAY UNIT

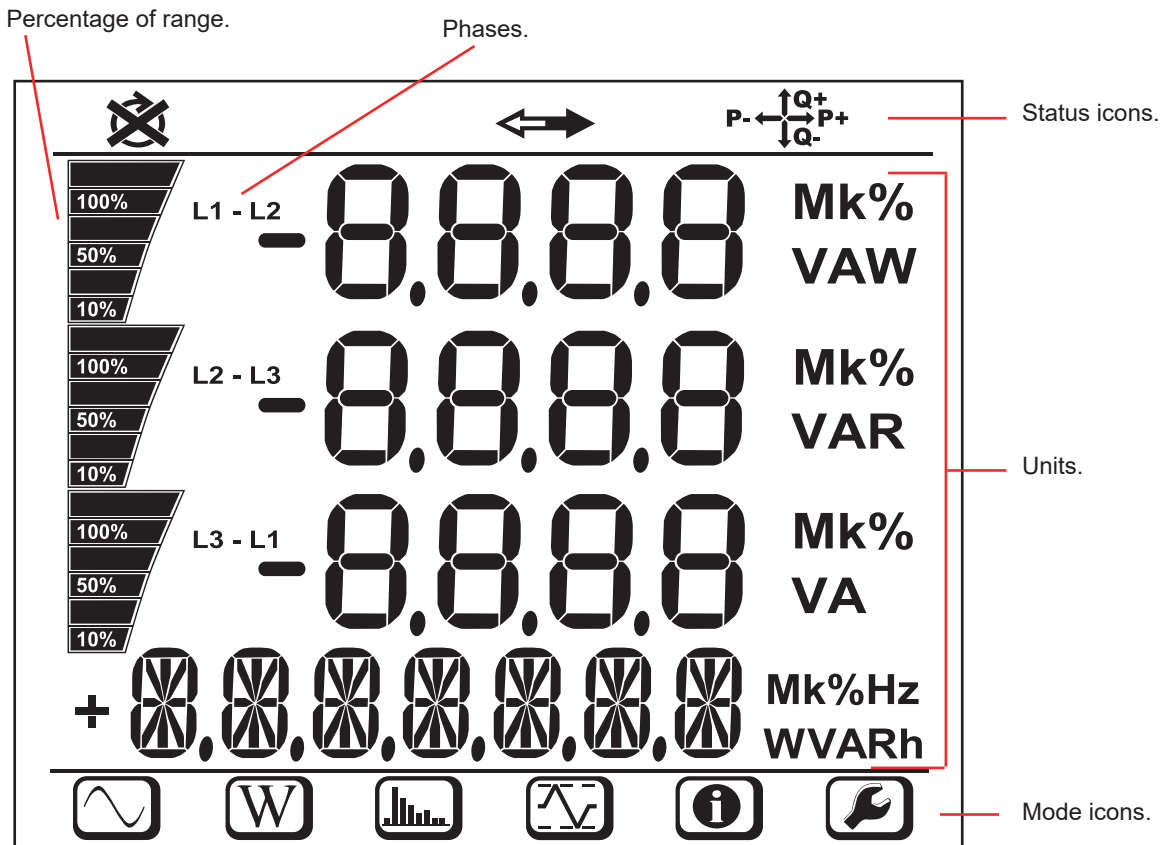

Figure 7

When there is no user activity for 3 minutes, the backlighting is switched off. To switch it back on, press one of the navigation keys (▲▼◀▶).

The bottom and top strips provide the following indications:

Icon	Description
	Indicator of a reversal of phase order or a missing phase (displayed for three-phase distribution networks, and only in measurement mode; see the explanation below)
	Data available for recording.
	Indication of the power quadrant.
	Measurement mode (instantaneous values). See § 4.3.1.
	Power and energy mode. See § 4.3.2.
	Harmonics mode. See § 4.3.3.
	Max. mode See § 4.3.4.
	Information mode. See § 3.6.
	Configuration mode. See § 3.5.

Table 3

Phase order

The phase order icon is displayed only when the measurement mode is selected.

The phase order is determined every second. If it is not correct, the symbol is displayed.

- The phase order for the voltage inputs is displayed only when the voltages are displayed.
- The phase order for the current inputs is displayed only when the currents are displayed.
- The phase order for the voltage and current inputs is displayed only when the powers are displayed.
- The source and load must be parameterized using PEL Transfer to define the direction of the energy (imported or exported).

2.7. INDICATORS

Indicators	Colour and function
	Green indicator: Mains Indicator lit: the instrument is connected to mains via the external power supply (optional mains power unit). Indicator off: the instrument is powered by the battery.
	Orang/red indicator: Battery Indicator off: battery fully charged. Orange indicator lit: battery charging. Indicator orange and blinking: battery is recovering from a full discharge. Indicator red and blinking: battery low (and no mains power).
	Red indicator: Phase order Indicator off: phase rotation order correct. Indicator blinking: phase rotation order incorrect, i.e., one of the following cases: <ul style="list-style-type: none"> ■ the phase difference between the phase currents is 30° greater than normal (120° in three-phase and 180° in two-phase). ■ the phase difference between the phase voltages is 10° greater than normal. ■ the phase difference between the currents and voltages of each phase is greater than 60° with respect to 0° (on a load) or 180° (on a source).
OL	Red indicator: Overshoot of the measurement range Indicator off: no overshoot on the inputs. Indicator blinking: overshoot on at least one input, a lead is missing or connected to the wrong terminal.





Indicators	Colour and function
	<p>Green/red indicator: SD card Green indicator lit: the SD card is recognized and not locked. Red indicator lit: SD card missing or locked or not recognized. Red indicator blinking: SD card being initialized. Indicator blinking alternately red and green: SD card full. Indicator light green and blinking: the SD card will be full before the end of the recording session in progress.</p>
	<p>Green indicator: Wi-Fi Indicator off: the Wi-Fi is not activated Indicator lit: the Wi-Fi is activated but not transmitting. Indicator blinking: transmission by Wi-Fi in progress.</p>
	<p>Green and yellow LEDs: Ethernet Green LED off: the Ethernet link is not activated. Green LED blinking: the Ethernet link is activated. Yellow LED off: the stack has not been initialized. Yellow LED blinking: the stack has been initialized correctly. Yellow LED blinking rapidly: acquisition of the new IP address. Yellow LED blinks twice and stops: the IP address assigned for the DHCP server is not valid. Yellow LED lit: the Ethernet link is transmitting.</p>
<p>REC</p>	<p>Red indicator: Recording Indicator off: no recording. Indicator blinking: recording session programmed. Indicator lit: recording in record mode.</p>
	<p>Green/orange indicator: On/Off Indicator lit green: the instrument is supplied by the voltage inputs. Indicator orange and blinking: the instrument is powered by the battery. Supply by the voltage inputs is deactivated (See § 3.1.4) or the supply voltage is too low.</p>

Table 4

2.8. MEMORY CARD

The PEL accepts SD, SDHC and SDXC cards, FAT32 formatted, up to a capacity of 32 GB.

The PEL is delivered with a formatted SD card. If you want to install a new SD card:

- Open the elastomer cap marked .
- Press on the SD card in the instrument, then withdraw it.



Attention : do not withdraw the SD card if recording is in progress.

- Check that the new SD card is not locked.
- It is best to format the SD card using the PEL Transfer software (see § 5), otherwise, format it using a PC.
- Insert the new card and push it home.
- Put the elastomer cap back on to keep the instrument tight.

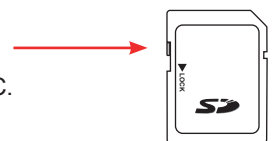

3. CONFIGURATION

The PEL must be configured before any recording. The various steps in this configuration are:

- Set up the USB link, the Ethernet link or the Wi-Fi link.
- Choose the connection according to the type of distribution network.
- Connect the current sensors.
- Define the nominal primary and secondary voltages if necessary.
- Define the nominal primary current and if necessary the nominal primary current of the neutral.
- Choose the aggregation period.

This configuration is done in the Configuration mode (see § 3.5) or using the PEL Transfer software (see § 5). To forestall accidental modifications, the PEL cannot be configured while recording or if a recording session has been programmed.

3.1. SWITCHING THE INSTRUMENT ON AND OFF

3.1.1. SWITCHING ON

- Connect the PEL to an electrical network (at least 100 V_{AC} or 140 V_{DC}) and it is switched on automatically (if supply via the voltage inputs has not been deactivated; see § 3.1.4). Otherwise, press the **On/Off**  key for more than 2 seconds. The green indicator below the **On/Off** key lights.



The battery automatically starts charging when the PEL is connected to a power or voltage source. The battery life is approximately one hour when it is fully charged. This enables the instrument to continue to operate if there is a brief power outage.

3.1.2. SWITCHING OFF

You cannot switch the PEL off while it is connected to a power source or while recording is in progress (or pending). This is a precaution intended to forestall any involuntary stoppage of a recording session by the user.

When it is disconnected from the power source and recording is over, the PEL switches itself off automatically after 3, 10, or 15 minutes, depending on the setting chosen.

Otherwise, to switch the PEL off:

- Disconnect all input terminals and the external power unit, if it is connected.
- Press the **On/Off** key for more than 2 seconds, until all indicators light, then release it.
- The PEL switches itself off and all indicators and the display unit go off.



3.1.3. STANBY MODE

With no user presence evident, the instrument goes into standby after three minutes (this duration can be programmed at 3, 10 or 15 minutes via the PEL Transfer application software). It continues to make measurements but they are no longer displayed. Standby mode can be inhibited.

The screen's blue backlight comes on at start-up. It turns off after 3 minutes. It turns on again when a key is pressed.

3.1.4. DE-ACTIVATION OF SUPPLY BY THE VOLTAGE INPUTS

Supply by the voltage inputs consumes from 10 to 15W. Some voltage generators cannot withstand this load. This applies to voltage calibrators and to capacitive voltage dividers. If you want to make measurements on these devices, supply to the instrument by the voltage inputs must be deactivated.

To deactivate supply to the instrument by the voltage inputs, press the **Selection**  and **On/Off**  keys simultaneously for more than 2 seconds. The **On/Off** key blinks orange.

To supply the instrument and recharge the battery, it is necessary to use the mains power unit sold as an option (see § 1.2).

3.2. BATTERY CHARGING

The battery is charged when the instrument is connected to a voltage source. But if supply by the voltage inputs has been deactivated (see previous section), the mains power unit must be used (optional).

110 - 250 V
50 / 60 Hz

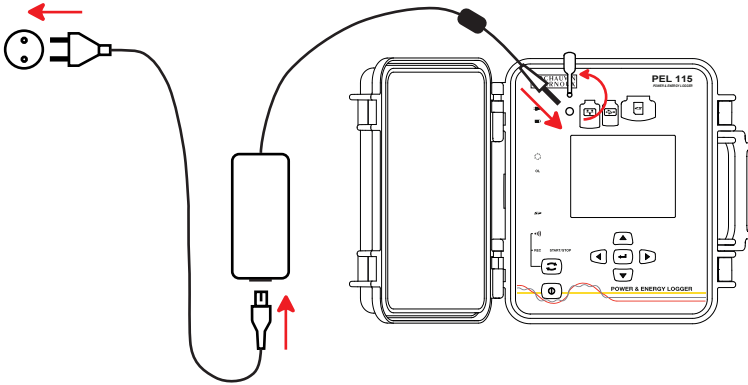



Figure 8

- Withdraw the elastomer cap that protects the power supply connector.
- Connect the mains power unit to the instrument and to mains.

The instrument comes on.

The  indicator lights until the battery is fully charged.

3.3. CONNECTION BY USB OR BY ETHERNET LAN LINK

The USB and Ethernet links can be used to configure the instrument using PEL Transfer software, to display the measurements, and to upload records to the PC.

- Withdraw the elastomer cap that protects the connector.
- Connect the USB cable provided or an Ethernet cable (not provided) between the instrument and the PC.



Before connecting the USB cable, install the drivers supplied with the PEL Transfer software (See § 5).

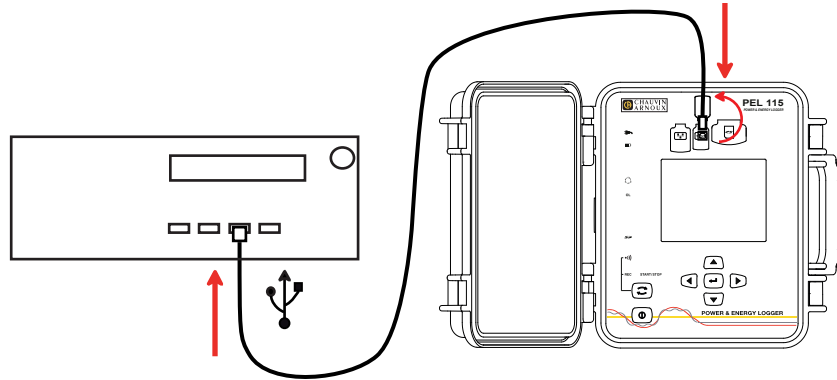

Figure 9

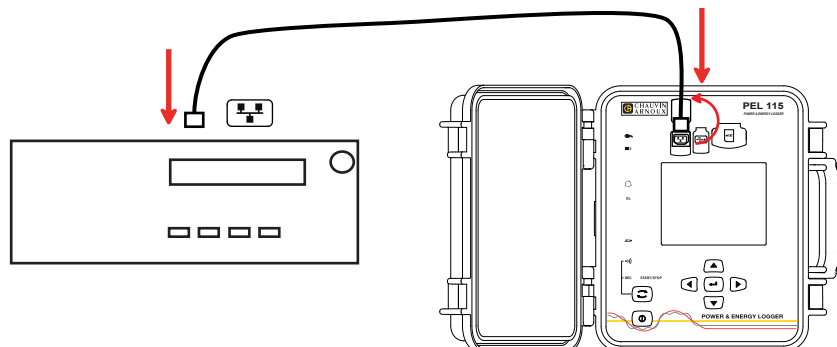

Figure 10

Then, whichever link was chosen, open the PEL Transfer software (see § 5) to connect the instrument to the PC.



Connecting the USB or Ethernet cable does not power up the instrument or charge the battery.

For the Ethernet LAN link, the PEL has an IP address.

When you configure the instrument with the PEL Transfer software, if the "Activate DHCP" (dynamic IP address) box is checked, the instrument sends a request to the network's DHCP server to obtain an IP address automatically.

The Internet protocol used is UDP or TCP. The port used by default is 3041. It can be modified in PEL Transfer so as to enable connections between the PC and several instruments behind a router.

The auto IP address mode is also available when the DHCP is selected and the DHCP server has not been detected within 60 seconds. The PEL will use 169.254.0.100 as default address. This auto IP address mode is compatible with APIPA.





A crossed cable may be necessary.



You can change the network parameters while connected via an Ethernet LAN link, but once the network parameters have been changed, you will lose connection. It is better to use a USB connection for this.

3.4. CONNECTION BY WI-FI LINK

This link can be used to configure the instrument using the PEL Transfer software, to view the measurements, and to upload the recordings to a PC, a smartphone, or a tablet.

- Press the **Selection**  key and hold it down. The **REC** and  indicators light in turn for 3 seconds each.
- Release the **Selection**  key while the desired function is lit.
 - If you release it while the **REC** indicator is lit, recording starts or stops.
 - If you release it while the  indicator is lit, the Wi-Fi is activated or deactivated.



When you press the **Select** button, if the **REC** indicator is blinking, the **Select** button is locked. The PEL Transfer software must be used to unlock it.

The data transmitted by the device can:

- go directly to a PC connected to it by Wi-Fi,
- pass via an IRD server (DataViewSync™) hosted by Chauvin Arnoux. To receive them on your PC, you must enable the IRD server (DataViewSync™) in PEL Transfer and specify whether the link is via Ethernet or Wi-Fi.

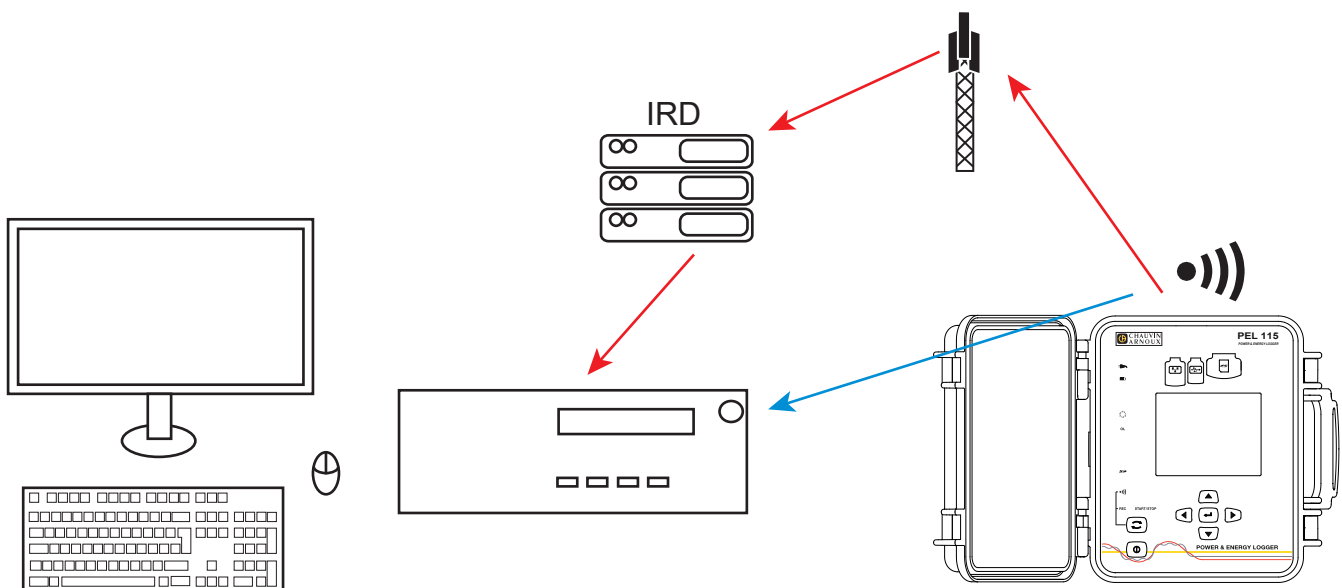



Figure 11

3.5. CONFIGURING THE INSTRUMENT

It is possible to configure some main functions directly on the instrument. For a complete configuration, use the PEL Transfer software (see § 5).

To enter the Configuration via the instrument mode, press the ◀ or ▶ key until the  symbol is selected.

The following screen is displayed:

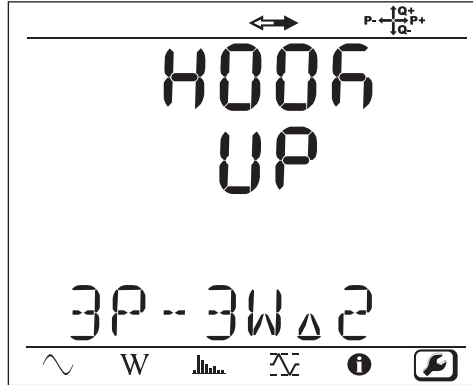



Figure 12

 If the PEL is already being configured via the PEL Transfer software, it is impossible to enter the Configuration mode in the instrument. In this case, when there is an attempt to configure it, the instrument displays **LOCK**.

3.5.1. TYPE OF NETWORK

To change the network, press the **Enter**  key. The name of the network blinks. Use the ▲ and ▼ keys to choose another network from among those in the list below.

Designation	Network
1P-2W	Single-phase, 2-wire
1P-3W	Single-phase, 3-wire
3P-3WΔ2	Three-phase, 3-wire Δ (2 current sensors)
3P-3WΔ3	Three-phase, 3-wire Δ (3 current sensors)
3P-3WΔb	Three-phase, 3-wire Δ, balanced
3P-4WY	Three-phase, 4-wire, wye
3P-4WYb	Three-phase, 4-wire, wye, balanced (voltage measurement, fixed)
3P-4WY2	Three-phase, 4-wire, wye 2½
3P-4WΔ	Three-phase, 4-wire Δ
3P-3WY2	Three-phase, 3-wire, wye (2 current sensors)
3P-3WY3	Three-phase, 3-wire, wye (3 current sensors)
3P-3WO2	Three-phase, 3-wire open Δ (2 current sensors)
3P-3WO3	Three-phase, 3-wire open Δ (3 current sensors)
3P-4WO	Three-phase, 4-wire, open Δ
dC-2W	DC 2-wire
dC-3W	DC 3-wire
dC-4W	DC 4-wire

Table 5

Validate your choice by pressing the **Enter**  key.

3.5.2. CURRENT SENSORS

Connect the current sensors to the instrument.

The current sensors are automatically detected by the instrument. It looks at the I1 terminal. If there is nothing, it looks at the I2 terminal, or the I3 terminal. If the network chosen has a current sensor on the N terminal, it also looks at the IN terminal.

Once the sensors have been recognized, the instrument displays their ratio.



The current sensors must all be the same, except for the neutral current sensor, which may be different. Otherwise, only the type of sensor connected to I1 will be used on the instrument.

3.5.3. NOMINAL PRIMARY VOLTAGE

Press the ▼ key to go to the next screen.

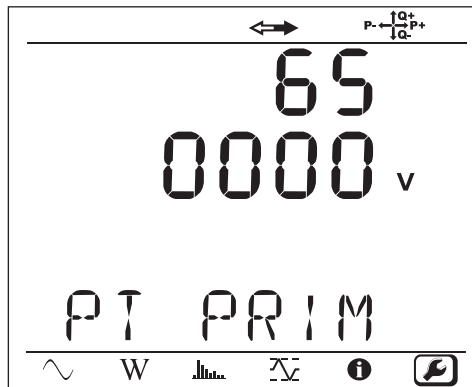





Figure 13

To change the nominal primary voltage, press the **Enter**  key. Use the ▲, ▼, ◀ and ▶ keys to choose the voltage, between 50 and 650,000 V. Then validate by pressing the **Enter**  key.

3.5.4. NOMINAL SECONDARY VOLTAGE

Press the ▼ key to go to the next screen.

To change the nominal secondary voltage, press the **Enter**  key. Use the ▲, ▼, ◀ and ▶ keys to choose the voltage, between 50 and 1,000 V. Then validate by pressing the **Enter**  key.

3.5.5. NOMINAL PRIMARY CURRENT

Press the ▼ key to go to the next screen.

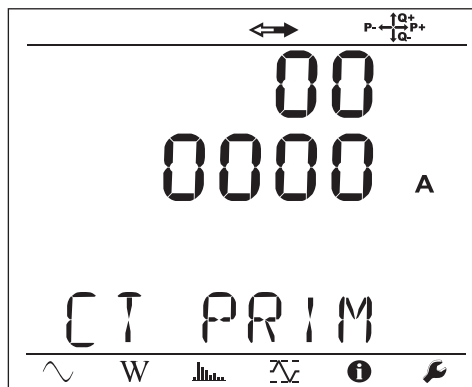



Figure 14

Depending on the type of current sensor, MiniFlex/AmpFlex®, MN clamp, or adapter unit, enter the nominal primary current. To do this, press the **Enter**  key. Use the ▲, ▼, ◀ and ▶ keys to choose the current.

- AmpFlex® A196A or A193 and MiniFlex MA194 or MA196: 100, 400, 2,000 or 10,000A (depending on the sensor)
- PAC93 clamp and C193 clamp: automatic at 1,000A
- MN93A clamp, 5A range, 5A Adapter: 5 to 25,000A
- MN93A clamp, 100A range: automatic at 100A
- MN93 clamp: automatic at 200A
- E94 clamp: 10 or 100A
- J93 clamp: automatic at 3,500 A

Validate the value by pressing the **Enter**  key.

3.5.6. NOMINAL PRIMARY CURRENT OF THE NEUTRAL

Press the ▼ key to go to the next screen.

If you connect a current sensor to the current terminal of the neutral, enter its nominal primary current too in the same way as before.

3.5.7. AGGREGATION PERIOD

Press the ▼ key to go to the next screen.

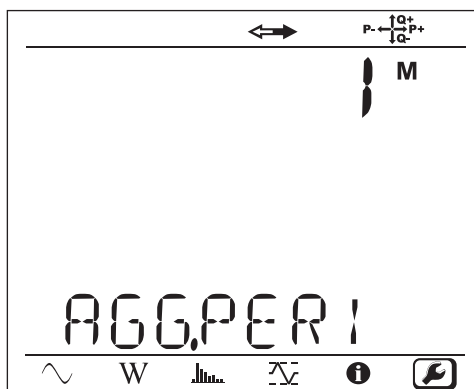



Figure 15

To change the aggregation period, press the **Enter**  key, then use the ▲ and ▼ keys to choose the value (1 to 6, 10, 12, 15, 20, 30, or 60 minutes).

Validate by pressing the **Enter**  key.

3.6. INFORMATION

To enter the Information mode, press the ◀ or ▶ key until the  symbol is selected.

Use the ▲ and ▼ keys to scroll the information of the instrument:

- Type of network

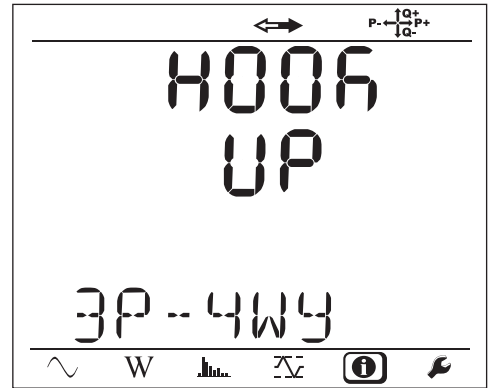

- Nominal primary voltage

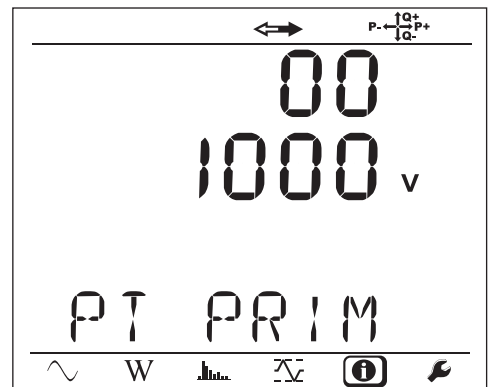

- Nominal secondary voltage

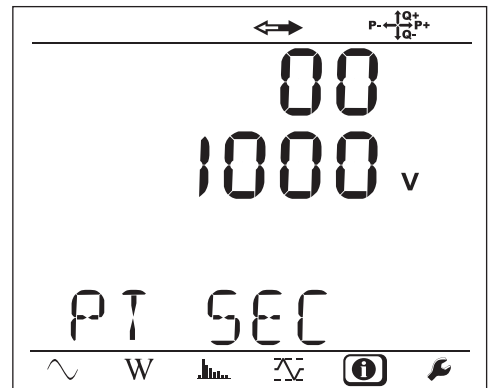

- Nominal primary current

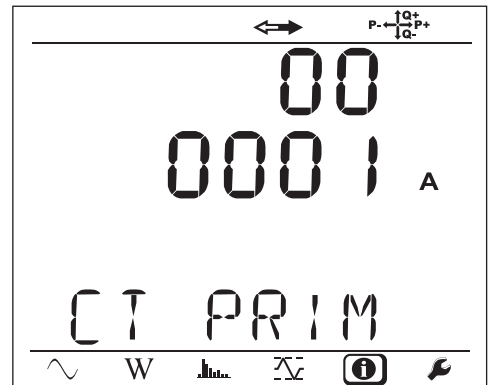

- Nominal primary current of the neutral (if a sensor is connected to the I_N terminal)

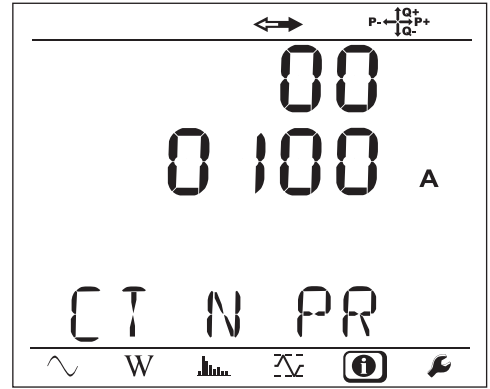

- Aggregation period

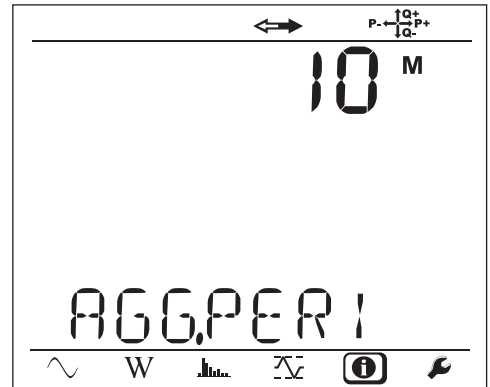

- Date and time

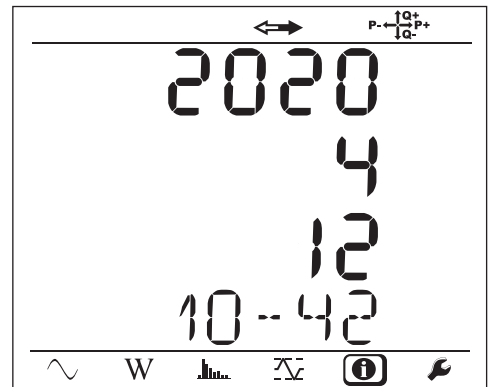

- IP address (scrolling)

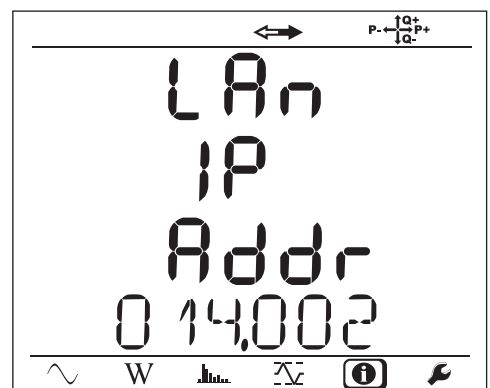

- Wi-Fi address (scrolling)

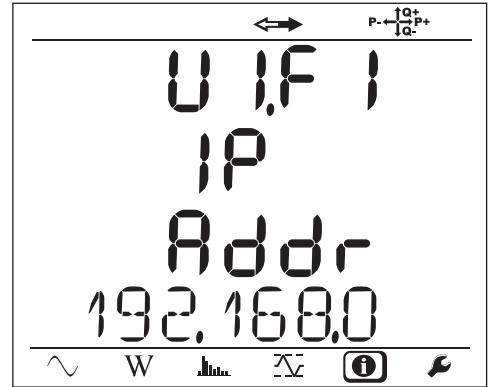

- Software version

- 1st number = software version of the DSP
- 2nd number = software version of the microprocessor
- Scrolling serial number (also on the QR code label glued to the inside of the cover of the PEL)

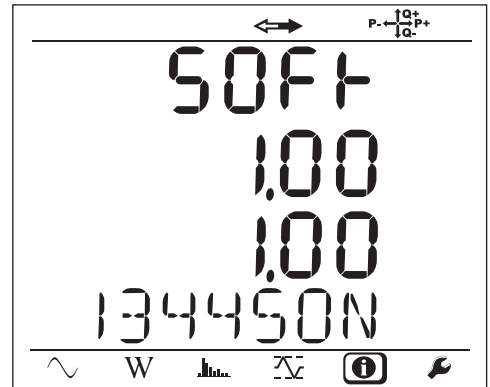

After 3 minutes with no action on the **Enter** or **Navigation** key, the display returns to the measurement screen .

4. USE

When the instrument has been configured, you can use it.

4.1. DISTRIBUTION NETWORKS AND CONNECTIONS OF THE PEL

Start by connecting the current sensors and the voltage measurement leads to your installation according to the type of distribution network. The PEL must be configured (see § 3.5) for the distribution network selected.



Always check that the arrow of the current sensor points towards the load. This ensures that the phase angle will be correct for power measurements and other measurements that depend on the phase.

However, when a recording session has ended and been uploaded to a PC, it is possible to change the direction of the current (I1, I2, or I3) using the PEL Transfer software. This makes it possible to correct the power calculations.

The crocodile clips can be screwed onto the voltage leads, keeping the assembly tight.



For measurements with a neutral, the current can be measured by a sensor or, if there is no sensor, calculated.

4.1.1. SINGLE-PHASE, 2-WIRE: 1P-2W

- Connect the N terminal to the neutral.
- Connect the VE/GND terminal to the earth (optional on this type of network).
- Connect the V1 terminal to the L1 phase.
- Connect the I1 current sensor to the L1 phase.
- Connect the IN current sensor to the common conductor (optional on this type of network).



Always check that the arrow of the current sensor points towards the load. This ensures that the phase angle will be correct for power measurements and other measurements that depend on the phase.

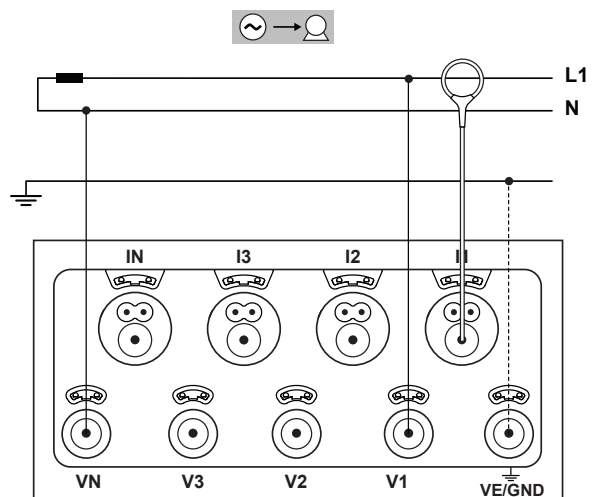

Figure 16

4.1.2. SPLIT-PHASE, 3-WIRE (SPLIT-PHASE FROM A CENTRE-TAP TRANSFORMER): 1P-3W

- Connect the N terminal to the neutral.
- Connect the VE/GND terminal to the earth (optional on this type of network).
- Connect the V1 terminal to the L1 phase.
- Connect the V2 terminal to the L2 phase.
- Connect the IN current sensor to the neutral (optional on this type of network).
- Connect the I1 current sensor to the L1 phase.
- Connect the I2 current sensor to the L2 phase.

i Always check that the arrow of the current sensor points towards the load. This ensures that the phase angle will be correct for power measurements and other measurements that depend on the phase.

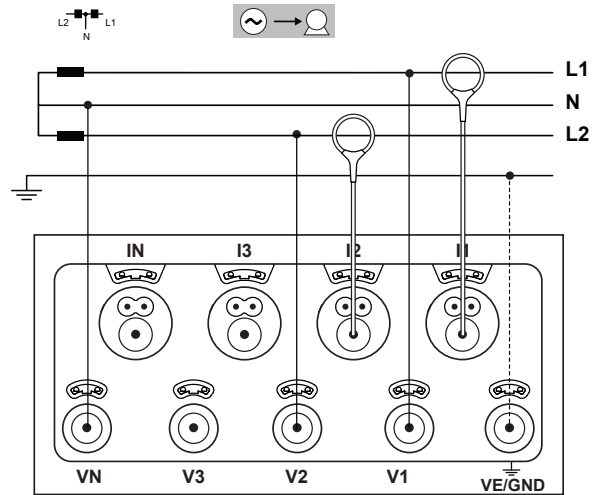

Figure 17

4.1.3. THREE-PHASE 3-WIRE SUPPLY NETWORKS

4.1.3.1. Three-phase, 3-wire, Δ (with 2 current sensors): 3P-3WΔ2

- Connect the VE/GND terminal to the earth.
- Connect the V1 terminal to the L1 phase.
- Connect the V2 terminal to the L2 phase.
- Connect the V3 terminal to the L3 phase.
- Connect the I1 current sensor to the L1 phase.
- Connect the I3 current sensor to the L3 phase.

i Always check that the arrow of the current sensor points towards the load. This ensures that the phase angle will be correct for power measurements and other measurements that depend on the phase.

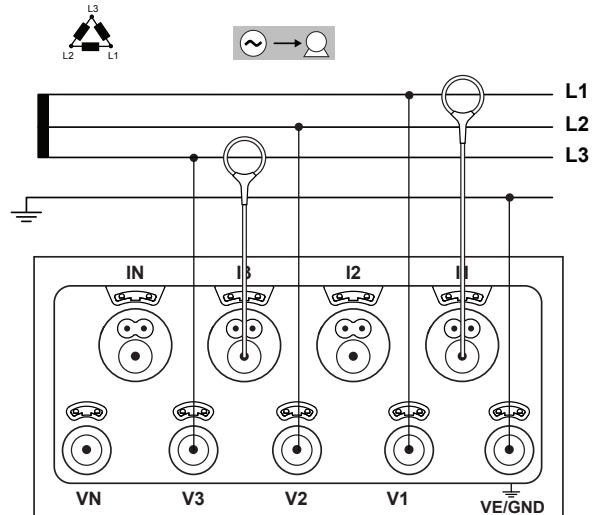

Figure 18

4.1.3.2. Three-phase, 3-wire, Δ (with 3 current sensors): 3P-3WΔ3

- Connect the VE/GND terminal to the earth.
- Connect the V1 terminal to the L1 phase.
- Connect the V2 terminal to the L2 phase.
- Connect the V3 terminal to the L3 phase.
- Connect the I1 current sensor to the L1 phase.
- Connect the I2 current sensor to the L2 phase.
- Connect the I3 current sensor to the L3 phase.

i Always check that the arrow of the current sensor points towards the load. This ensures that the phase angle will be correct for power measurements and other measurements that depend on the phase.

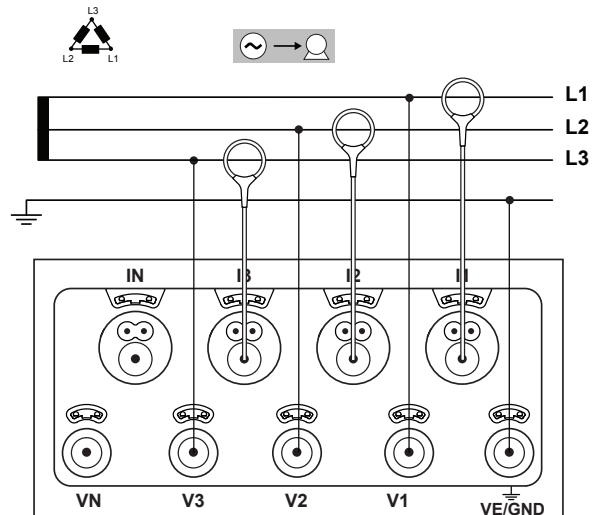

Figure 19

4.1.3.3. Three-phase, 3-wire open Δ (with 2 current sensors): 3P-3W02

- Connect the VE/GND terminal to the earth.
- Connect the V1 terminal to the L1 phase.
- Connect the V2 terminal to the L2 phase.
- Connect the V3 terminal to the L3 phase.
- Connect the I1 current sensor to the L1 phase.
- Connect the I3 current sensor to the L3 phase.



Always check that the arrow of the current sensor points towards the load. This ensures that the phase angle will be correct for power measurements and other measurements that depend on the phase.

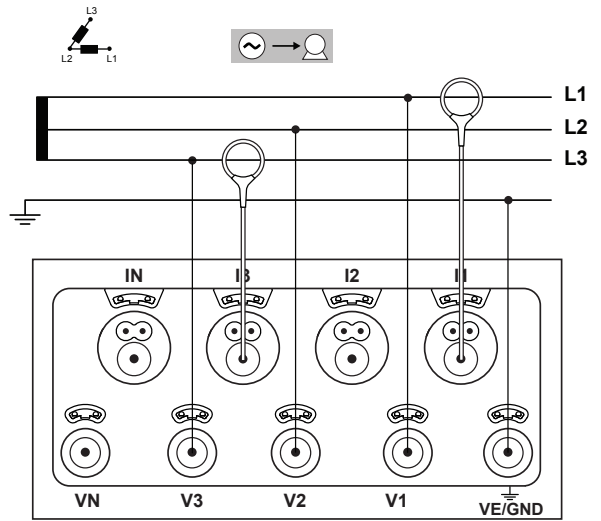

Figure 20

4.1.3.4. Three-phase, 3-wire open Δ (with 3 current sensors): 3P-3W03

- Connect the VE/GND terminal to the earth.
- Connect the V1 terminal to the L1 phase.
- Connect the V2 terminal to the L2 phase.
- Connect the V3 terminal to the L3 phase.
- Connect the I1 current sensor to the L1 phase.
- Connect the I2 current sensor to the L2 phase.
- Connect the I3 current sensor to the L3 phase.



Always check that the arrow of the current sensor points towards the load. This ensures that the phase angle will be correct for power measurements and other measurements that depend on the phase.

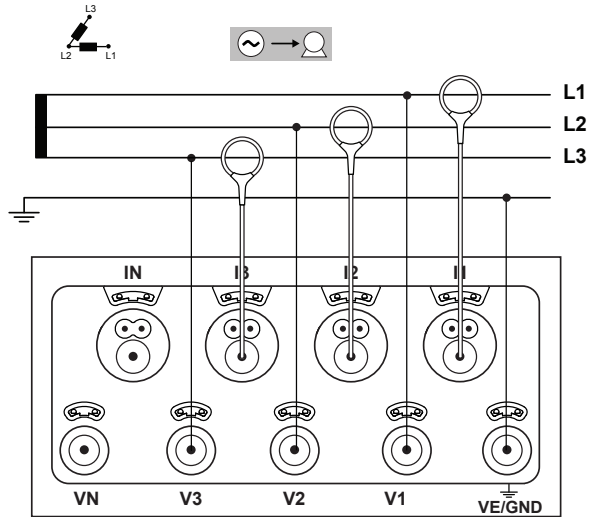

Figure 21

4.1.3.5. Three-phase, 3-wire, wye (with 2 current sensors): 3P-3WY2

- Connect the VE/GND terminal to the earth.
- Connect the V1 terminal to the L1 phase.
- Connect the V2 terminal to the L2 phase.
- Connect the V3 terminal to the L3 phase.
- Connect the I1 current sensor to the L1 phase.
- Connect the I3 current sensor to the L3 phase.



Always check that the arrow of the current sensor points towards the load. This ensures that the phase angle will be correct for power measurements and other measurements that depend on the phase.

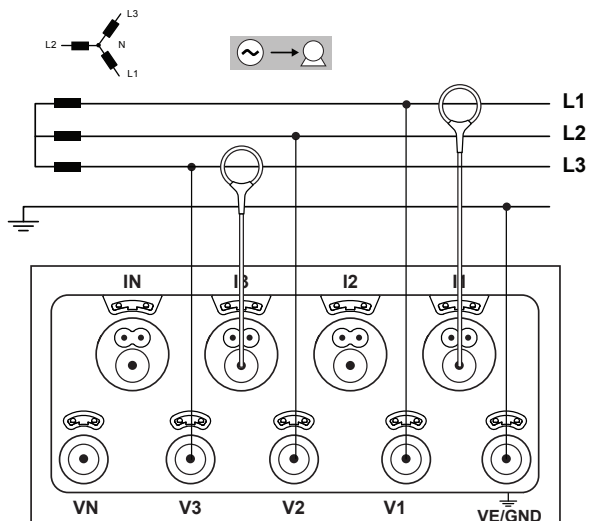

Figure 22

4.1.3.6. Three-phase, 3-wire, wye (with 3 current sensors): 3P-3WY

- Connect the VE/GND terminal to the earth.
- Connect the V1 terminal to the L1 phase.
- Connect the V2 terminal to the L2 phase.
- Connect the V3 terminal to the L3 phase.
- Connect the I1 current sensor to the L1 phase.
- Connect the I2 current sensor to the L2 phase.
- Connect the I3 current sensor to the L3 phase.

i Always check that the arrow of the current sensor points towards the load. This ensures that the phase angle will be correct for power measurements and other measurements that depend on the phase.

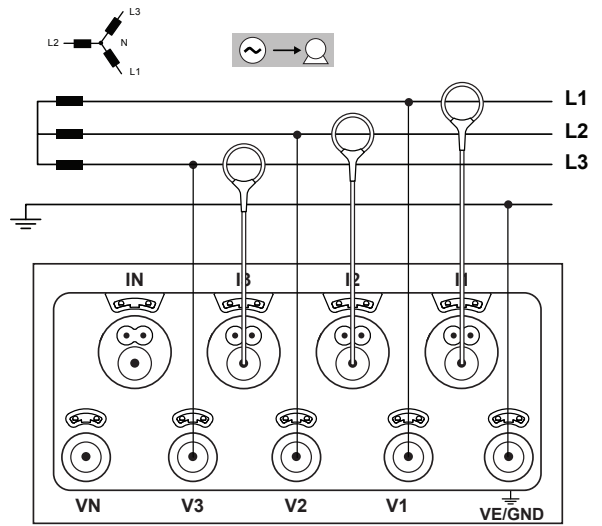

Figure 23

4.1.3.7. Three-phase, 3-wire Δ balanced (with 1 current sensor): 3P-3W03

- Connect the VE/GND terminal to the earth.
- Connect the V1 terminal to the L1 phase.
- Connect the V2 terminal to the L2 phase.
- Connect the I3 current sensor to the L3 phase.

i Always check that the arrow of the current sensor points towards the load. This ensures that the phase angle will be correct for power measurements and other measurements that depend on the phase.

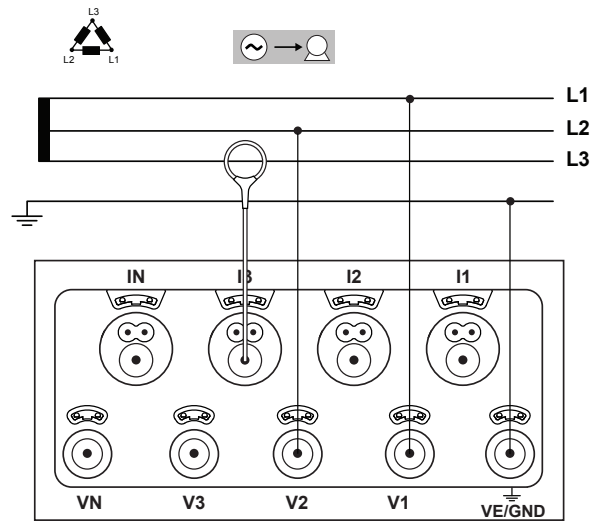

Figure 24

4.1.4. THREE-PHASE 4-WIRE WYE SUPPLY NETWORKS

4.1.4.1. Three-phase, 4-wire, wye (with 4 current sensors): 3P-4WY

- Connect the N terminal to the neutral.
- Connect the VE/GND terminal to the earth.
- Connect the V1 terminal to the L1 phase.
- Connect the V2 terminal to the L2 phase.
- Connect the V3 terminal to the L3 phase.
- Connect the IN current sensor to the neutral.
- Connect the I1 current sensor to the L1 phase.
- Connect the I2 current sensor to the L2 phase.
- Connect the I3 current sensor to the L3 phase.

i Always check that the arrow of the current sensor points towards the load. This ensures that the phase angle will be correct for power measurements and other measurements that depend on the phase.

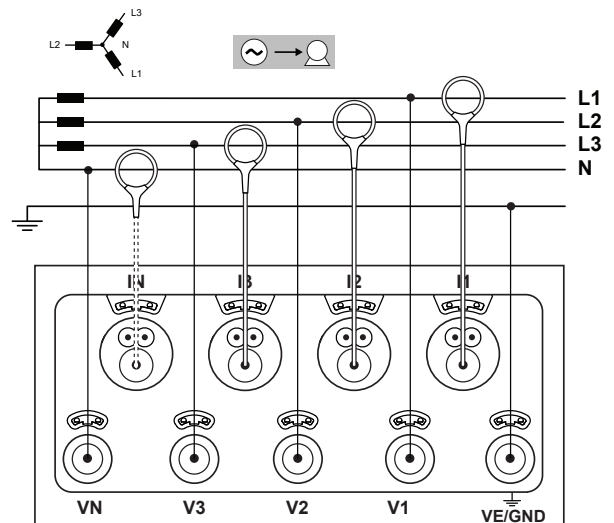

Figure 25

4.1.4.2. Three-phase, 4-wire, wye, balanced (with 2 current sensors): 3P-4WYB

- Connect the N terminal to the neutral.
- Connect the VE/GND terminal to the earth.
- Connect the V1 terminal to the L1 phase.
- Connect the IN current sensor to the neutral.
- Connect the I1 current sensor to the L1 phase.



Always check that the arrow of the current sensor points towards the load. This ensures that the phase angle will be correct for power measurements and other measurements that depend on the phase.

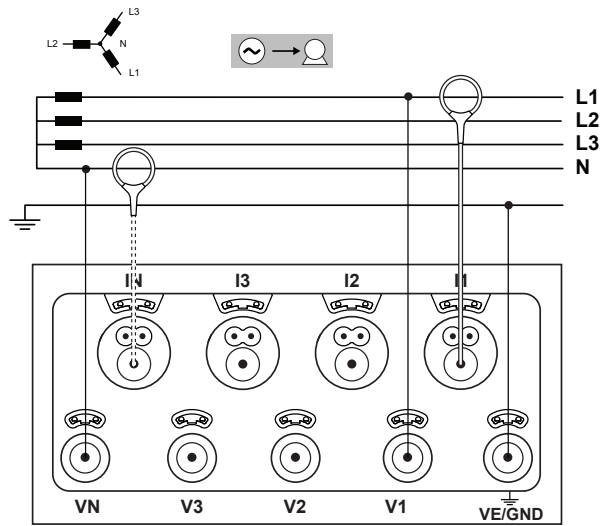

Figure 26

4.1.4.3. Three-phase, 4-wire, wye 2½-elements (with 4 current sensors): 3P-4WY2

- Connect the N terminal to the neutral.
- Connect the VE/GND terminal to the earth.
- Connect the V1 terminal to the L1 phase.
- Connect the V3 terminal to the L3 phase.
- Connect the IN current sensor to the neutral.
- Connect the I1 current sensor to the L1 phase.
- Connect the I2 current sensor to the L2 phase.
- Connect the I3 current sensor to the L3 phase.



Always check that the arrow of the current sensor points towards the load. This ensures that the phase angle will be correct for power measurements and other measurements that depend on the phase.

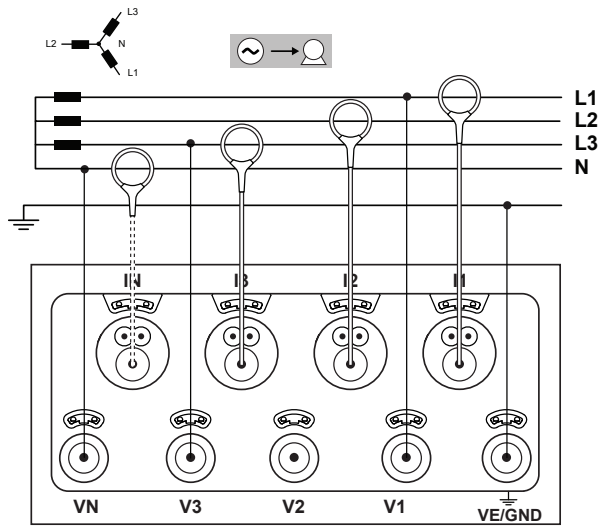

Figure 27

4.1.5. THREE-PHASE, 4-WIRE Δ

Three-phase 4-wire Δ (High Leg) configuration. No voltage transformer is connected: the installation measured is assumed to be a LV (low-voltage) distribution network.

4.1.5.1. Three-phase, 4-wire Δ (with 4 current sensors): 3P-4WΔ

- Connect the N terminal to the neutral.
- Connect the VE/GND terminal to the earth.
- Connect the V1 terminal to the L1 phase.
- Connect the V2 terminal to the L2 phase.
- Connect the V3 terminal to the L3 phase.
- Connect the IN current sensor to the neutral.
- Connect the I1 current sensor to the L1 phase.
- Connect the I2 current sensor to the L2 phase.
- Connect the I3 current sensor to the L3 phase.

i Always check that the arrow of the current sensor points towards the load. This ensures that the phase angle will be correct for power measurements and other measurements that depend on the phase.

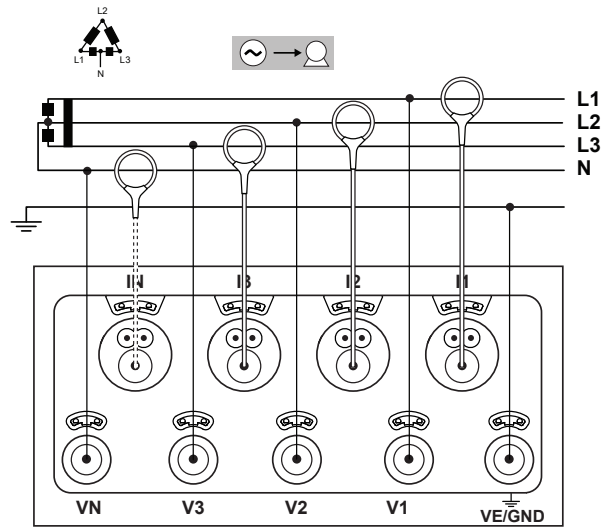

Figure 28

4.1.5.2. Three-phase, 4-wire, open Δ (with 4 current sensors): 3P-4WO

- Connect the N terminal to the neutral.
- Connect the VE/GND terminal to the earth.
- Connect the V1 terminal to the L1 phase.
- Connect the V2 terminal to the L2 phase.
- Connect the V3 terminal to the L3 phase.
- Connect the IN current sensor to the neutral.
- Connect the I1 current sensor to the L1 phase.
- Connect the I2 current sensor to the L2 phase.
- Connect the I3 current sensor to the L3 phase.

i Always check that the arrow of the current sensor points towards the load. This ensures that the phase angle will be correct for power measurements and other measurements that depend on the phase.

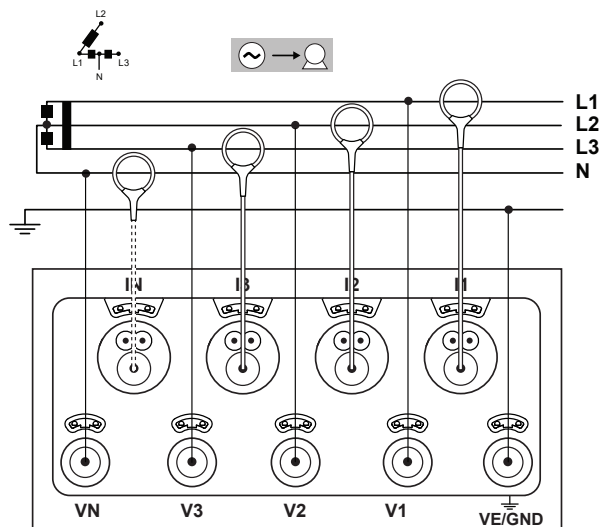



Figure 29

4.1.6. DC SUPPLY NETWORKS

4.1.6.1. DC 2-wire: DC-2W

- Connect the N terminal to the common conductor.
- Connect the VE/GND terminal to the earth.
- Connect the V1 terminal to the +1 conductor.
- Connect the IN current sensor to the common conductor.
- Connect the current sensor I1 to the +1 conductor.

 Always check that the arrow of the current sensor points towards the load. This ensures that the phase angle will be correct for power measurements and other measurements that depend on the phase.

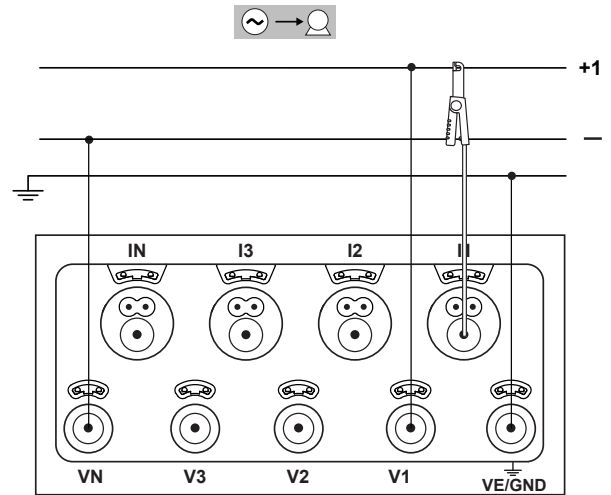



Figure 30

4.1.6.2. DC 3-wire: DC-3W

- Connect the N terminal to the common conductor.
- Connect the VE/GND terminal to the earth.
- Connect the V1 terminal to the +1 conductor.
- Connect the V2 terminal to the +2 conductor.
- Connect the IN current sensor to the common conductor.
- Connect the current sensor I1 to the +1 conductor.
- Connect the current sensor I2 to the +2 conductor.

 Always check that the arrow of the current sensor points towards the load. This ensures that the phase angle will be correct for power measurements and other measurements that depend on the phase.

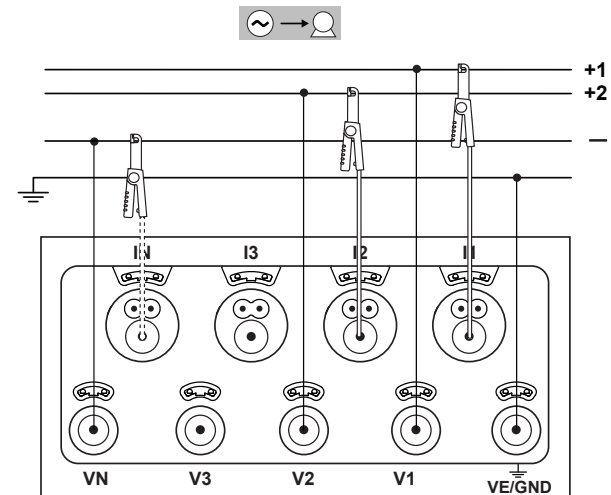



Figure 31

4.1.6.3. DC 4-wire: DC-4W

- Connect the N terminal to the common conductor.
- Connect the VE/GND terminal to the earth.
- Connect the V1 terminal to the +1 conductor.
- Connect the V2 terminal to the +2 conductor.
- Connect the V3 terminal to the +3 conductor.
- Connect the IN current sensor to the common conductor.
- Connect the current sensor I1 to the +1 conductor.
- Connect the current sensor I2 to the +2 conductor.
- Connect the current sensor I3 to the +3 conductor.

 Always check that the arrow of the current sensor points towards the load. This ensures that the phase angle will be correct for power measurements and other measurements that depend on the phase.

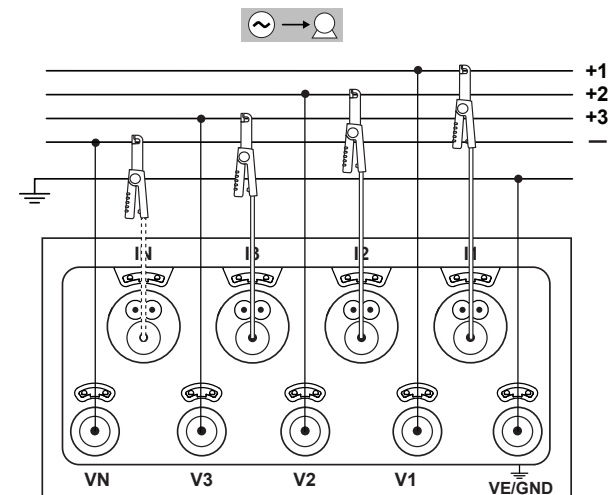





Figure 32

4.2. RECORDING

To start recording:

- Check that there is in fact an SD card (not locked and not full) in the PEL.
- Press the **Selection**  key and hold it down. The **REC** and  indicators light in turn for 3 seconds each.
- Release the **Selection**  key while the **REC** indicator is lit. Recording starts and the **REC** indicator starts blinking twice every 5 seconds.





To stop recording, proceed in exactly the same way. The **REC** indicator starts blinking once every 5 seconds.

It is possible to manage recording from PEL Transfer (see § 5).

If the instrument is cut off by a power outage, the measurement campaign resumes when the instrument is switched back on.

4.3. MEASURED-VALUE DISPLAY MODES

The PEL has 4 display modes, represented by the icons at the bottom of the display unit. To change from one mode to the other, use the ◀ or ▶ key.

Icon	Display mode
	Instantaneous values display mode: voltage (V), current (I), active power (P), reactive power (Q), apparent power (S), frequency (f), power factor (PF), $\tan \Phi$.
	Power and energy display mode: active energy of the load (Wh), reactive energy of the load (Varh), apparent energy of the load (VAh).
	Current and voltage harmonics display mode.
	Maximum values display mode: maximum aggregated values of the measurements and energy of the last recording.

The displays are accessible as soon as the PEL is on, but the values are zero. As soon as there is a voltage or current on the inputs, the values are updated.

4.3.1. MEASUREMENT MODE

The display depends on the network configured. Press the \blacktriangledown key to go from one screen to the next.

Single-phase, 2-wire (1P-2W)

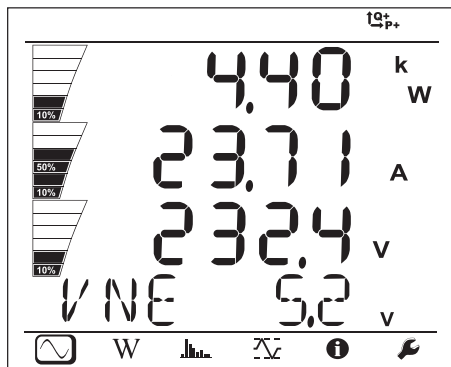

P
I
V
V_N

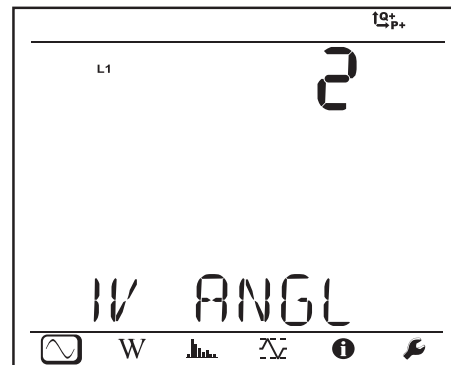

$\varphi (I_1, V_1)$

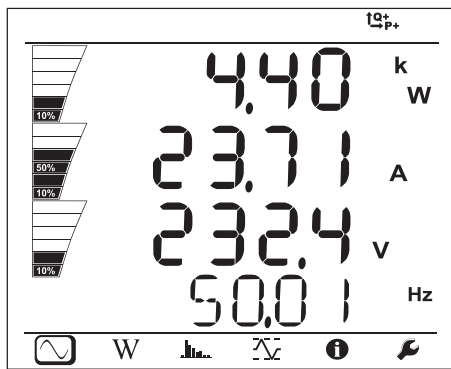

P
I
V
f

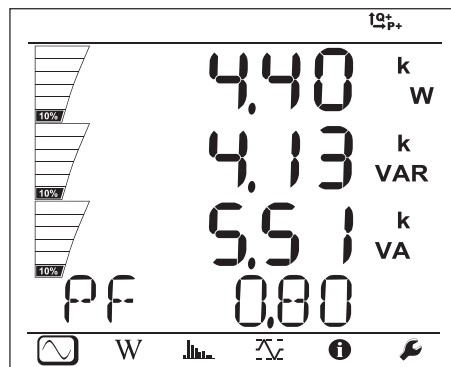

P
Q
S
PF

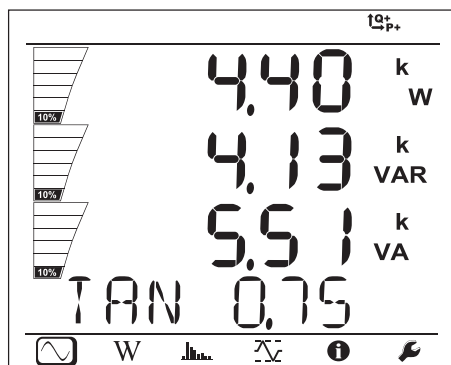

P
Q
S
tan φ

Two-phase, 3-wire (1P-3W)

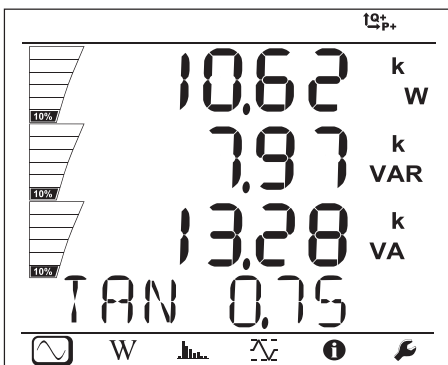
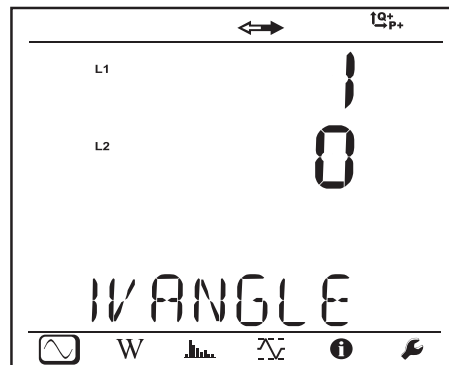
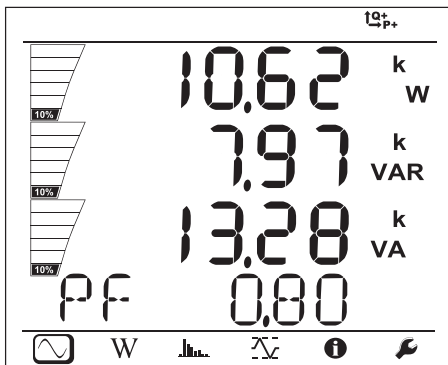
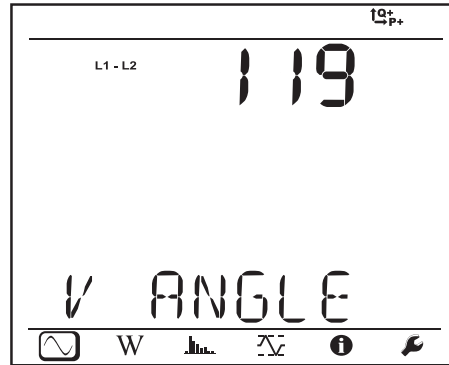
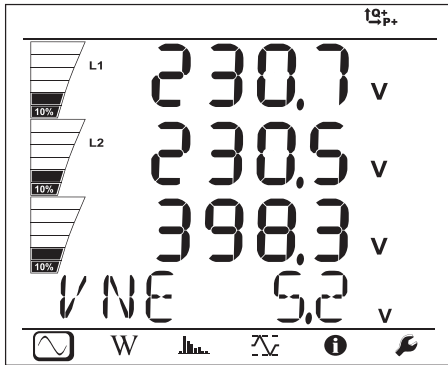
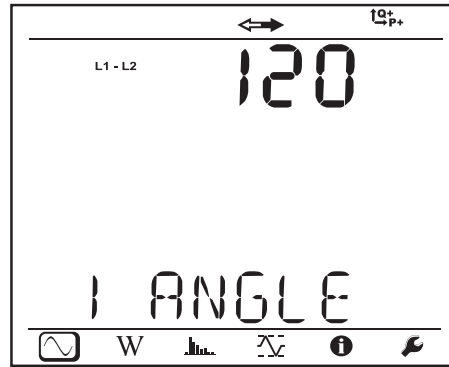
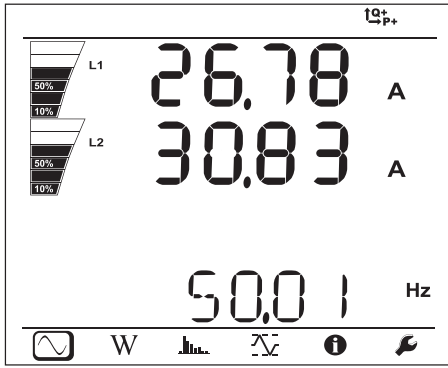

Three-phase, 3-wire, unbalanced (3P-3WΔ2, 3P-3WΔ3, 3P-3WO2, 3P-3WO3, 3P-3WY2, 3P-3WY3)

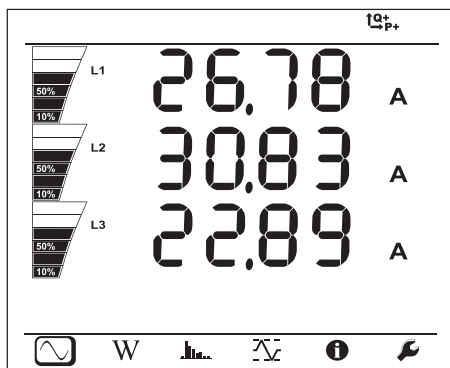

I_1

I_2

I_3

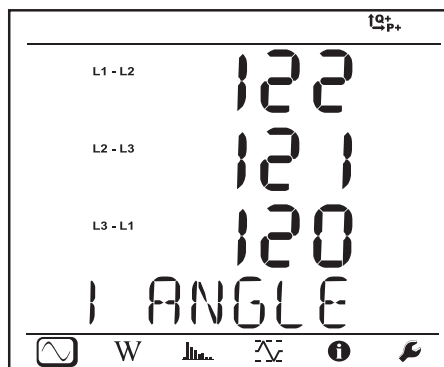

$\phi(I_2, I_1)$

$\phi(I_3, I_2)$

$\phi(I_1, I_3)$

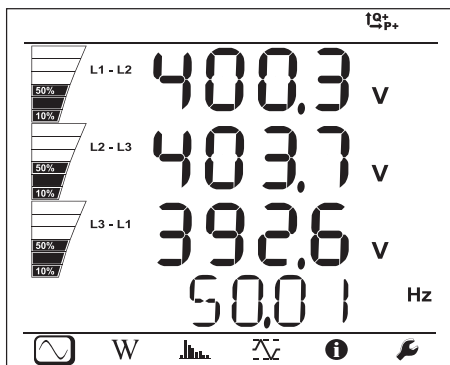

U_{12}

U_{23}

U_{31}

f

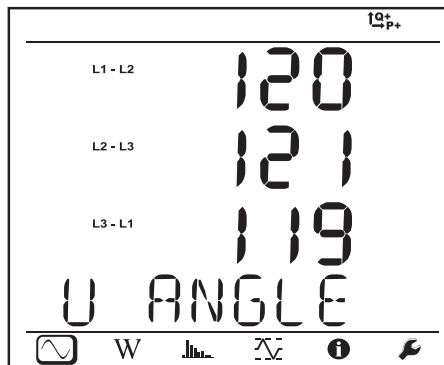

$\phi(U_{31}, U_{23})$

$\phi(U_{12}, U_{31})$

$\phi(U_{23}, U_{12})$

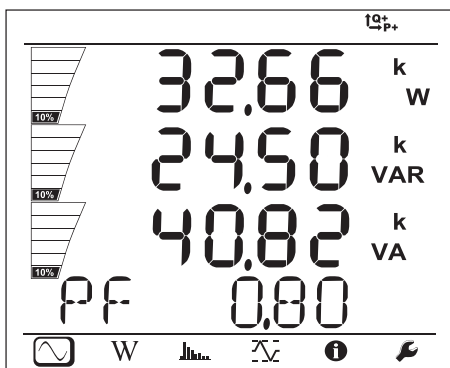

P

Q

S

PF

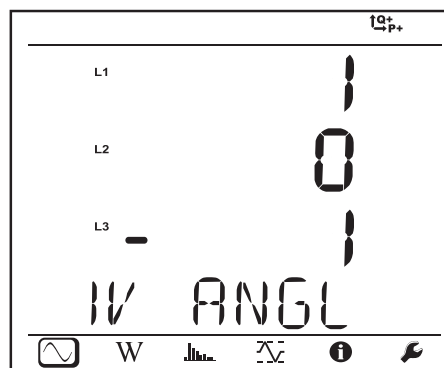

$\phi(I_1, U_{12})$

$\phi(I_2, U_{23})$

$\phi(I_2, U_{31})$

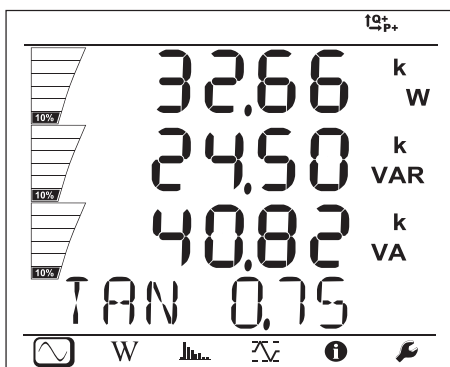

P

Q

S

tan ϕ

Three-phase, 3-wire Δ , balanced (3P-3W Δ b)

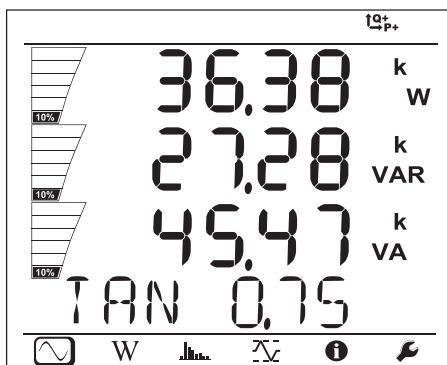
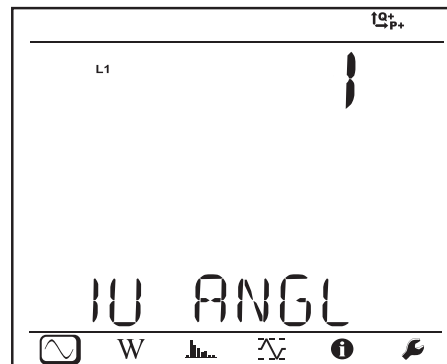
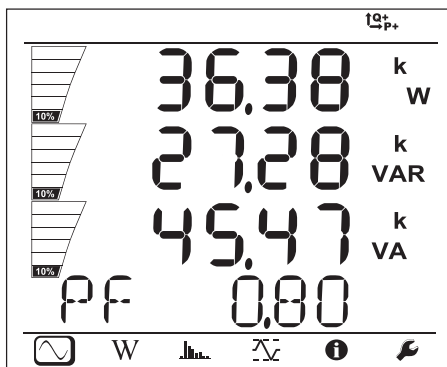
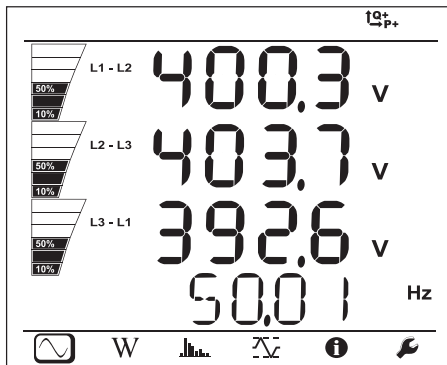
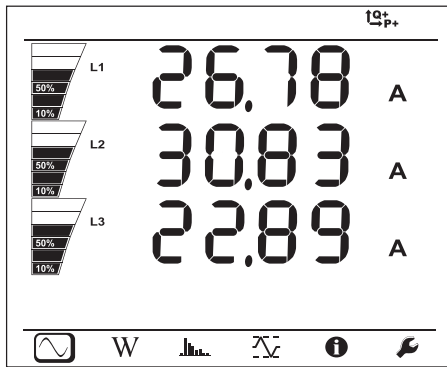

Three-phase, 4-wire, unbalanced (3P-4WY, 3P-4WY2, 3P-4WΔ, 3P-4WO)

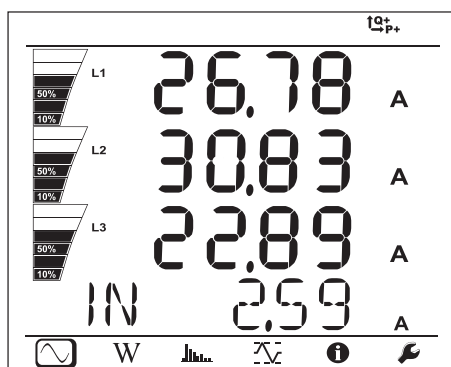

I_1
 I_2
 I_3
 I_N

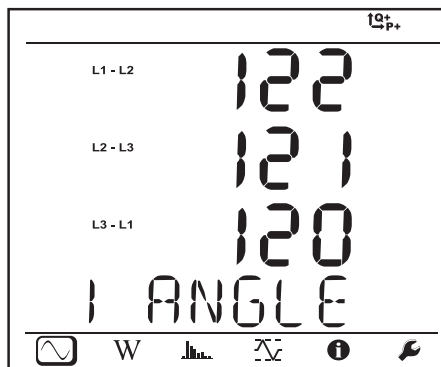

$\phi(I_2, I_1)$
 $\phi(I_3, I_2)$
 $\phi(I_1, I_3)$

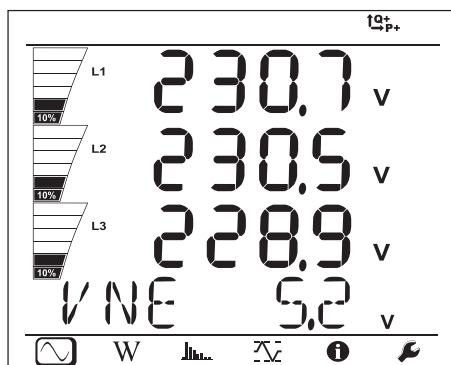

V_1
 V_2
 V_3
 V_N

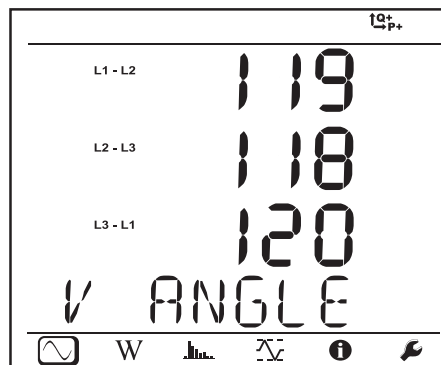

$\phi(V_2, V_1)^*$
 $\phi(V_3, V_2)^*$
 $\phi(V_1, V_3)$

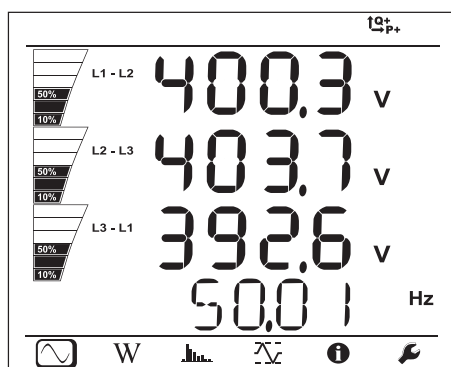

U_{12}
 U_{23}
 U_{31}
f

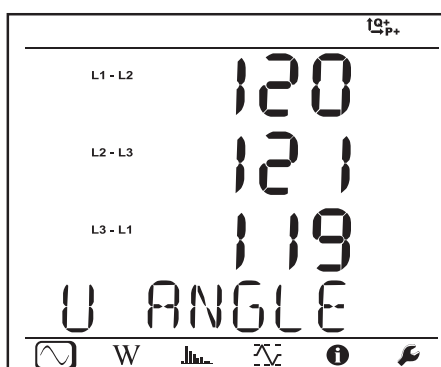

$\phi(U_{31}, U_{23})$
 $\phi(U_{12}, U_{31})$
 $\phi(U_{23}, U_{12})$

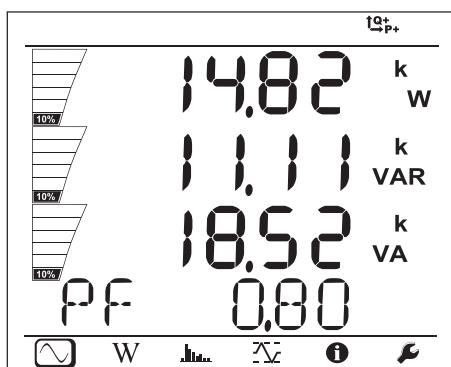

P
Q
S
PF

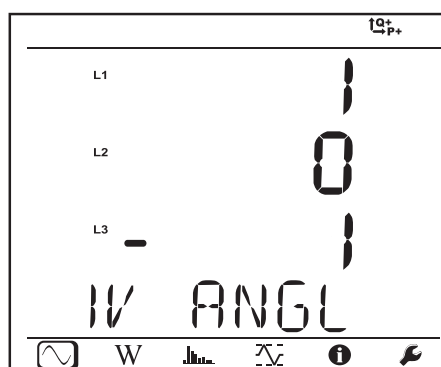

$\phi(I_1, V_1)$
 $\phi(I_2, V_2)^*$
 $\phi(I_3, V_3)$

*: For 3P-4WΔ and 3P-4WO networks

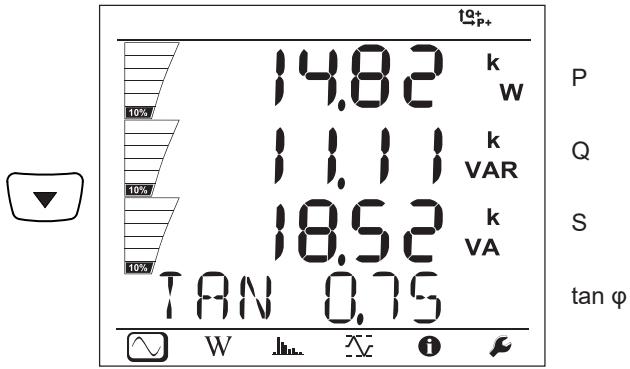

Three-phase, 4-wire, wye, balanced (3P-4WYb)

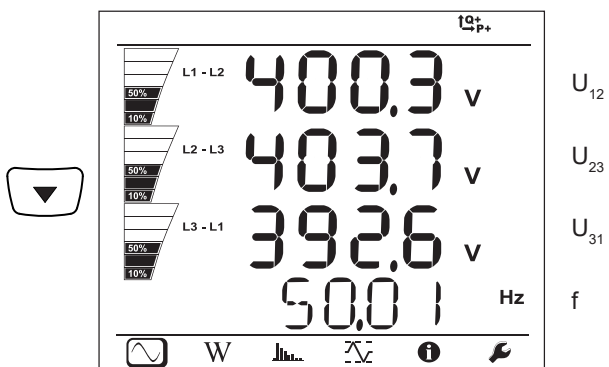
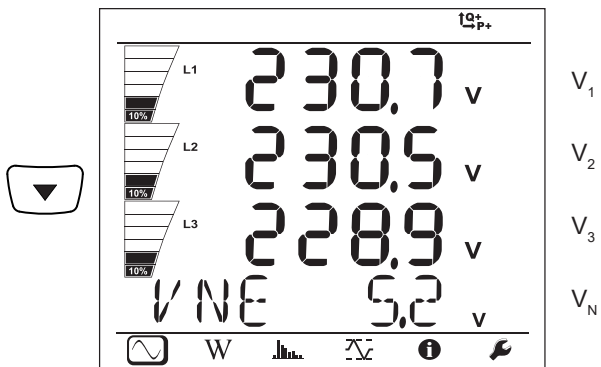
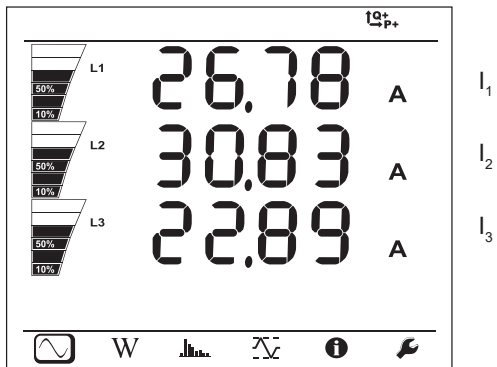

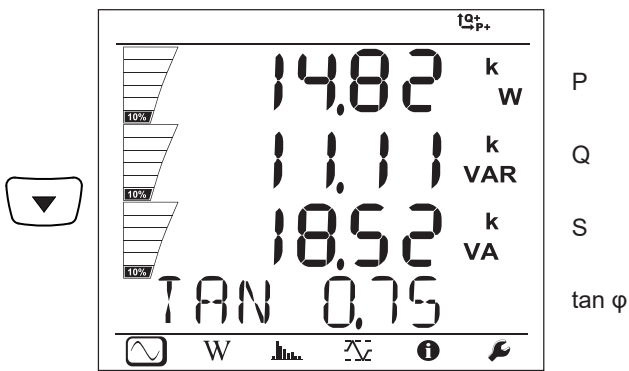
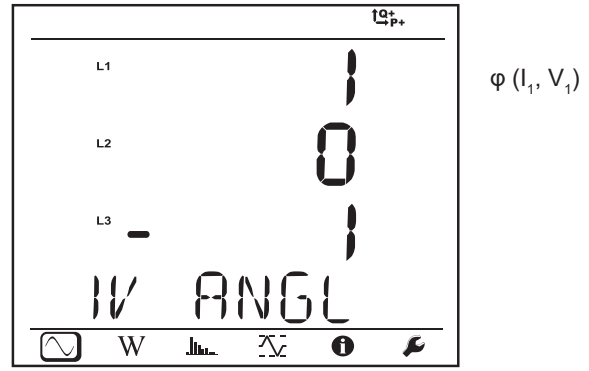
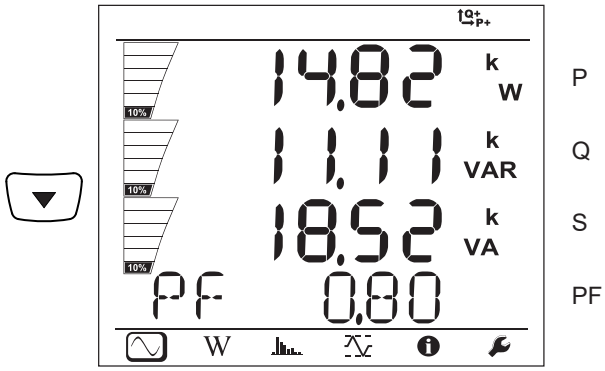

DC 2-wire, (dC-2W)

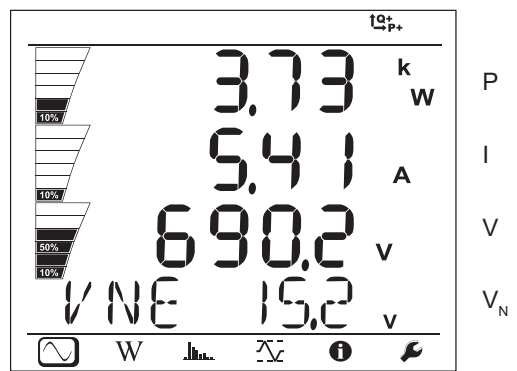

DC 3-wire, (dC-3W)

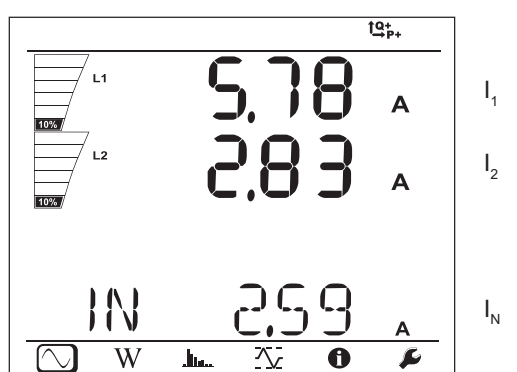

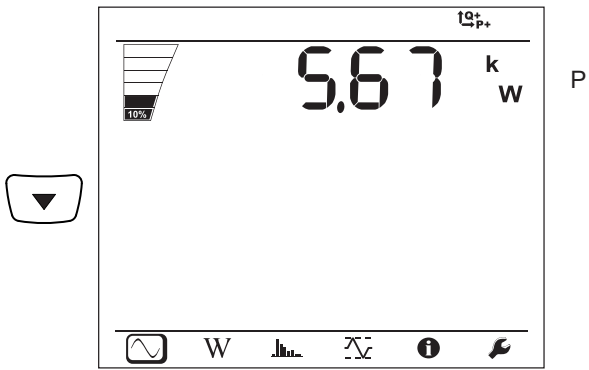
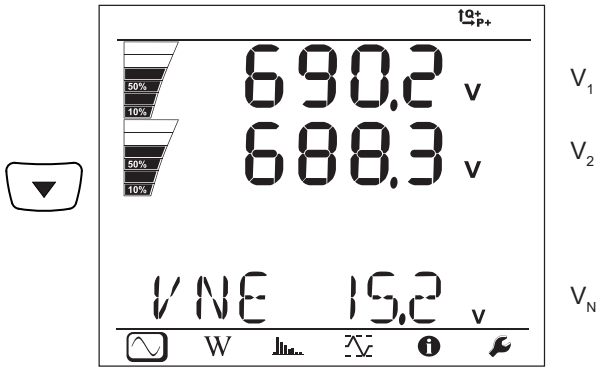

DC 4-wire, (dC-4W)

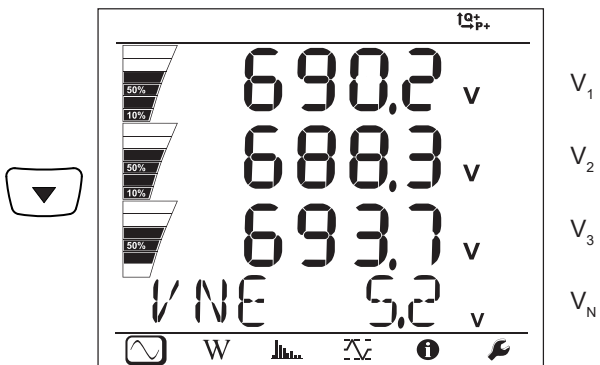
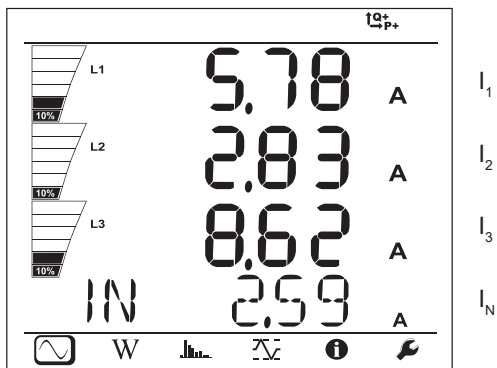

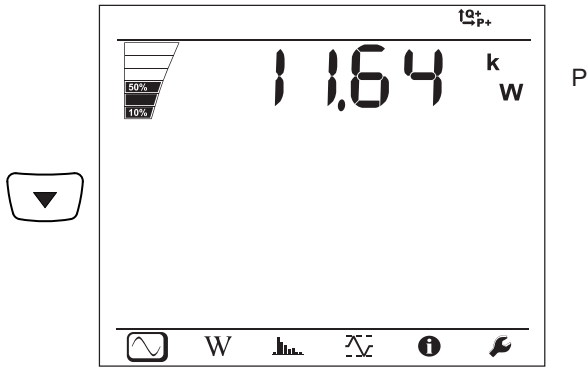

4.3.2. ENERGY MODE

The powers displayed are the total powers. The energy depends on the duration; typically it is available at the end of 10 or 15 minutes or at the end of the aggregation period.

Press the **Enter**  key for more than 2 seconds to obtain the powers by quadrant (IEC 62053-23). The display unit indicates **PArt** to specify that the values are partial.

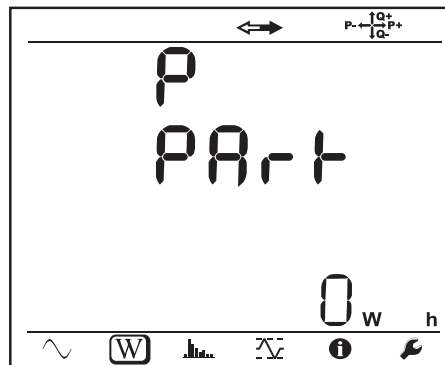

Figure 33

Press the **▼** key to return to display of the total powers.

The display screens for AC and DC networks are different

AC networks

Ep+: Total active energy consumed (by the load) in kWh

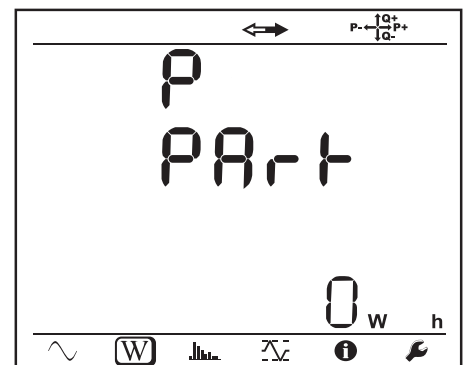
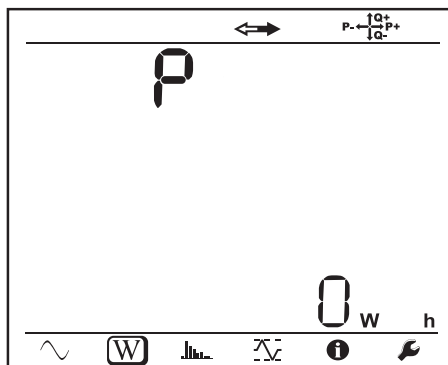

Ep-: Total active energy delivered (by the source) in kWh

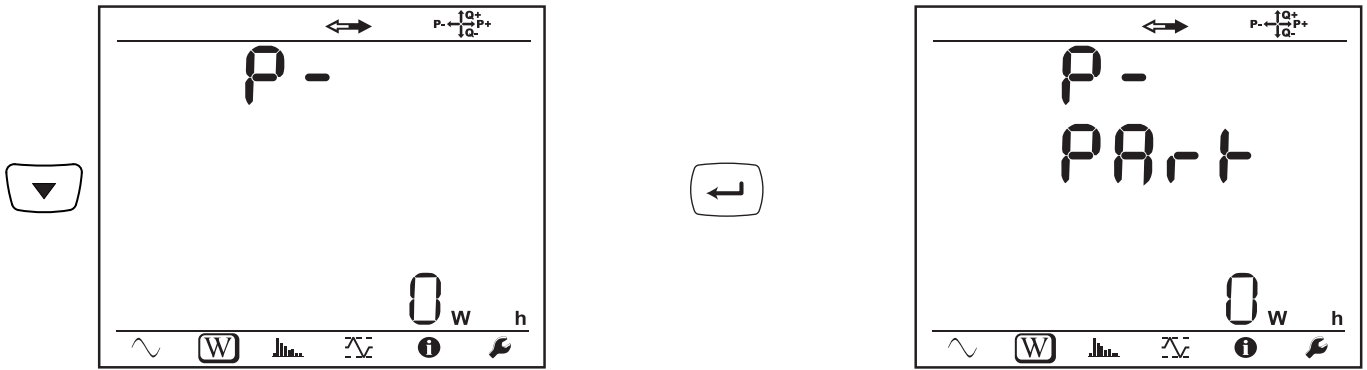

Eq1: Reactive energy consumed (by the load) in the inductive quadrant (quadrant 1) in kvarh.

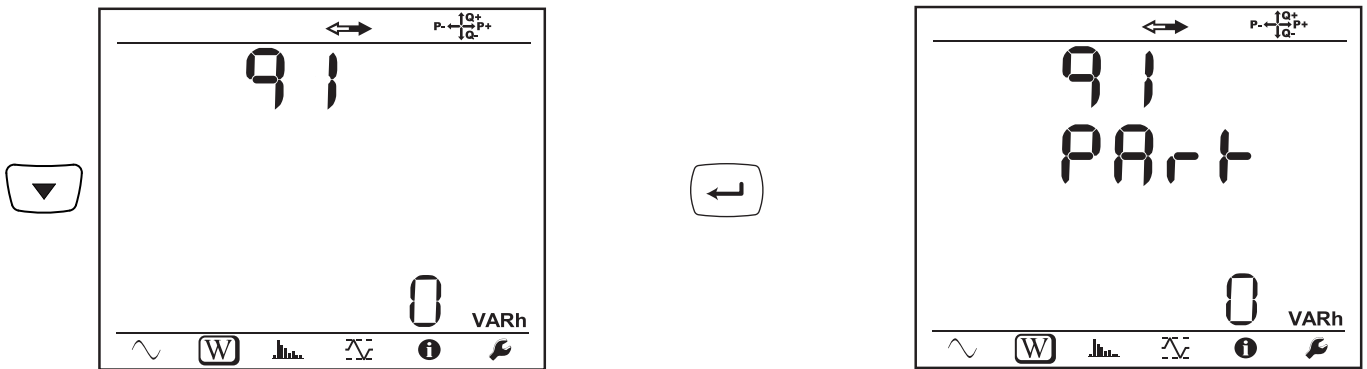

Eq2: Reactive energy delivered (by the source) in the capacitive quadrant (quadrant 2) in kvarh.

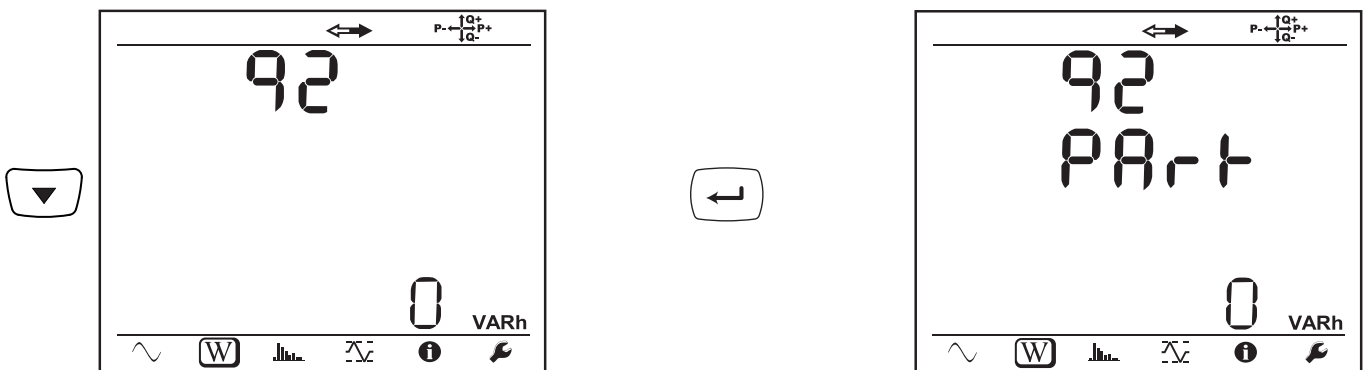

Eq3: Reactive energy delivered (by the source) in the inductive quadrant (quadrant 3) in kvarh.

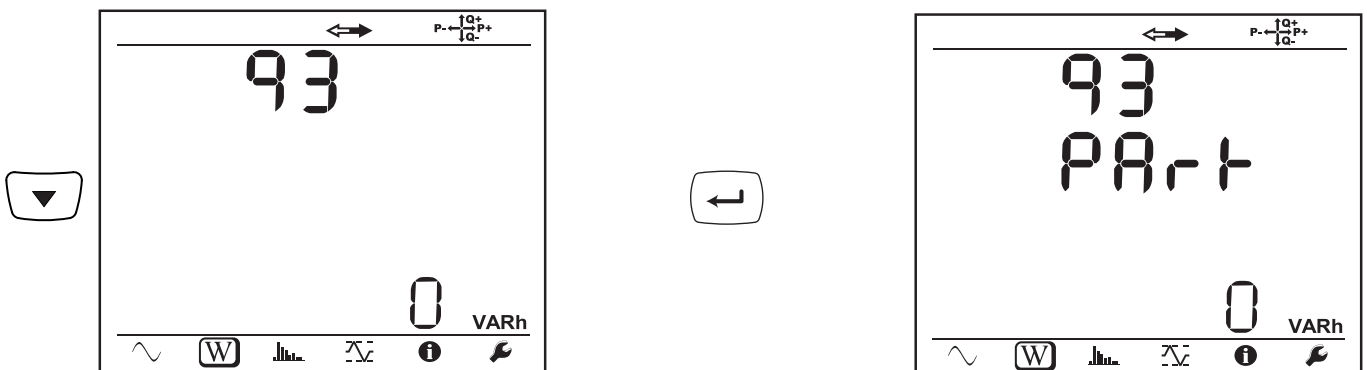

Eq4: Reactive energy consumed (by the load) in the capacitive quadrant (quadrant 4) in kvarh.

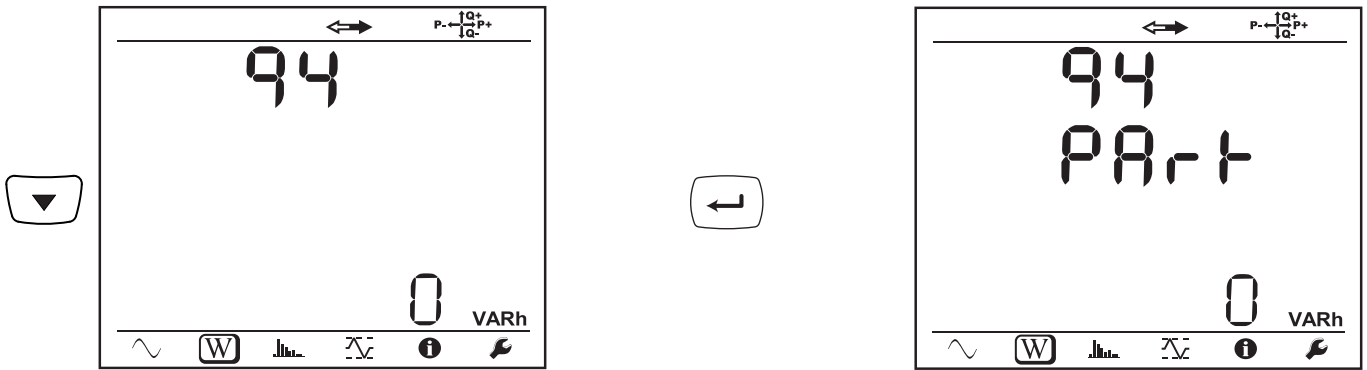

Es+: Total apparent energy consumed (by the load) in kVAh

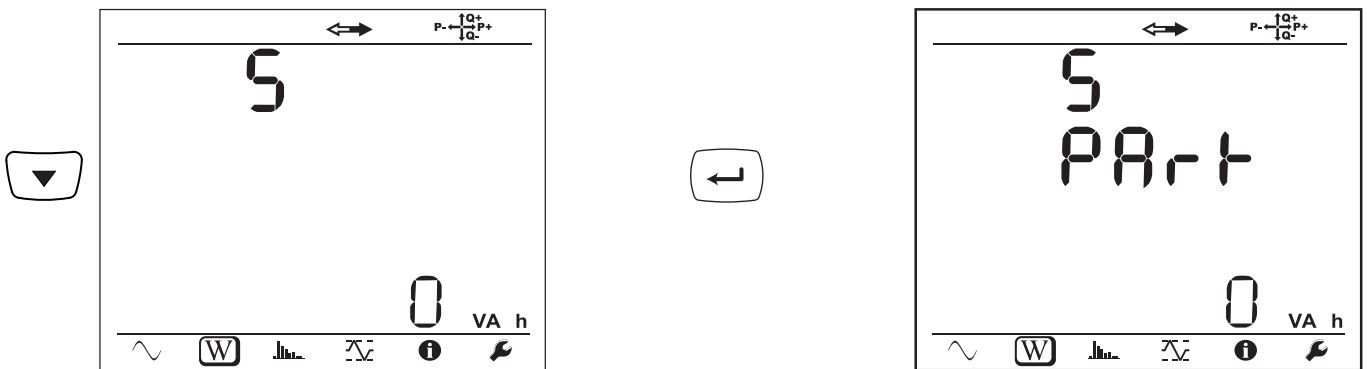

Es-: Total apparent energy delivered (by the source) in kVAh

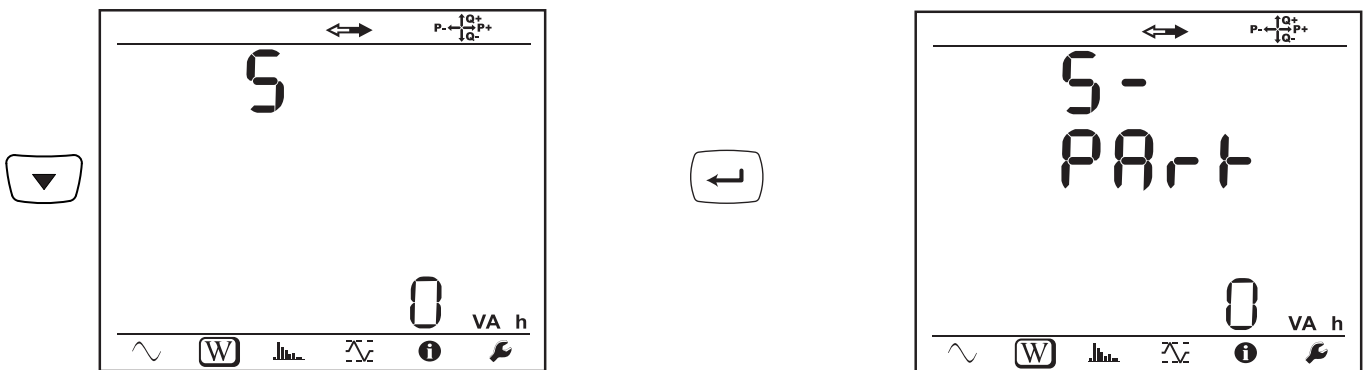

DC networks

Ep+: Total active energy consumed (by the load) in kWh

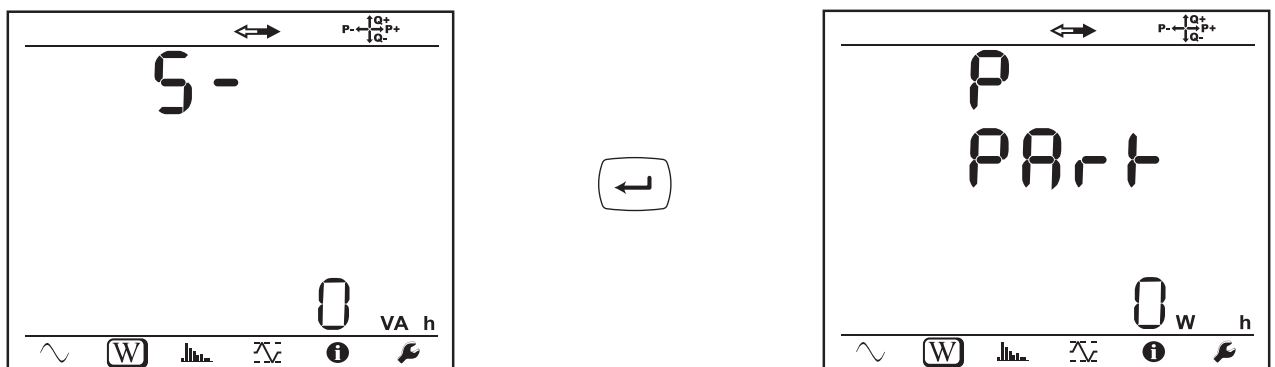

Ep-: Total active energy delivered (by the source) in kWh

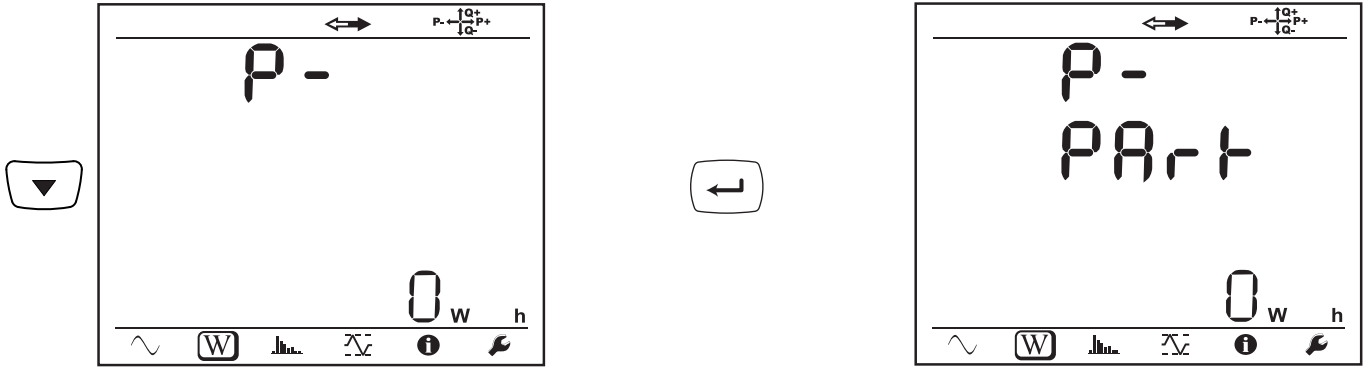

4.3.3. HARMONICS MODE

The display depends on the network configured.
 The harmonics display is not available for DC networks. The display unit indicates "No THD in DC mode".

Single-phase, 2-wire (1P-2W)

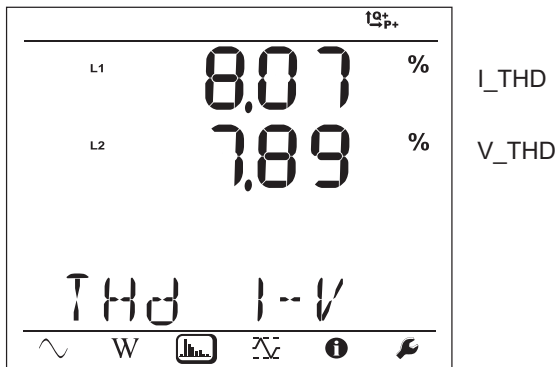

Two-phase, 3-wire (1P-3W)

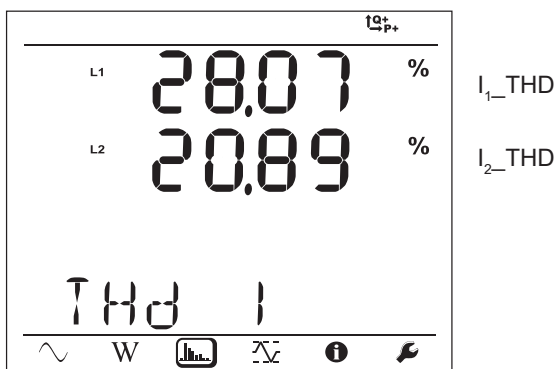

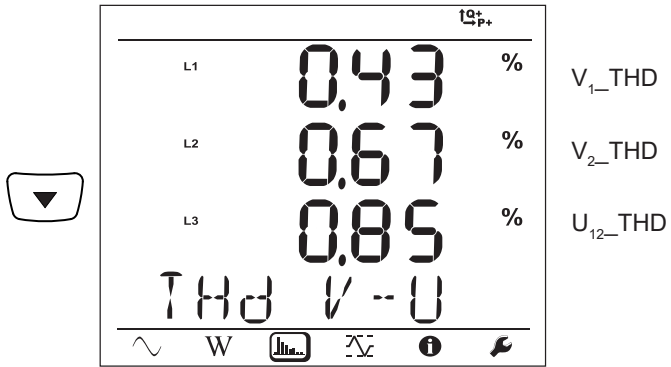

Three-phase, 3-wire, unbalanced (3P-3WΔ2, 3P-3WΔ3, 3P-3WO2, 3P-3WO3, 3P-3WY2, 3P-3WY3)

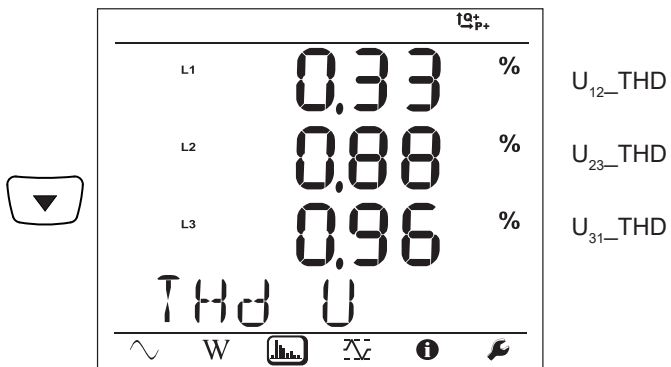
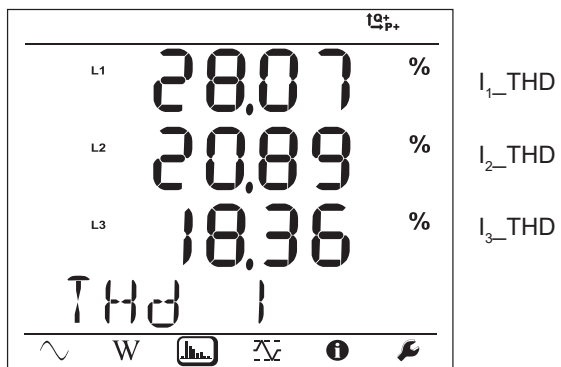

Three-phase, 3-wire Δ, balanced (3P-3WΔb)

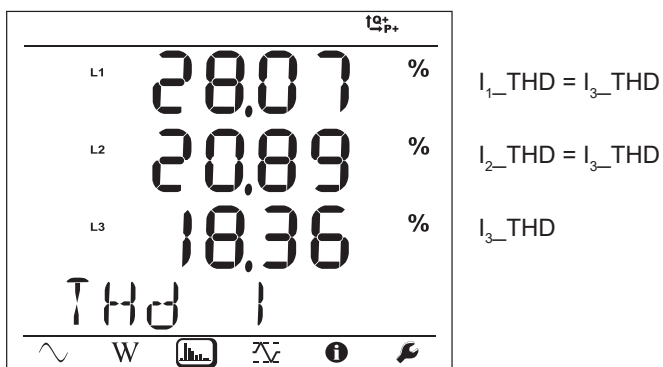

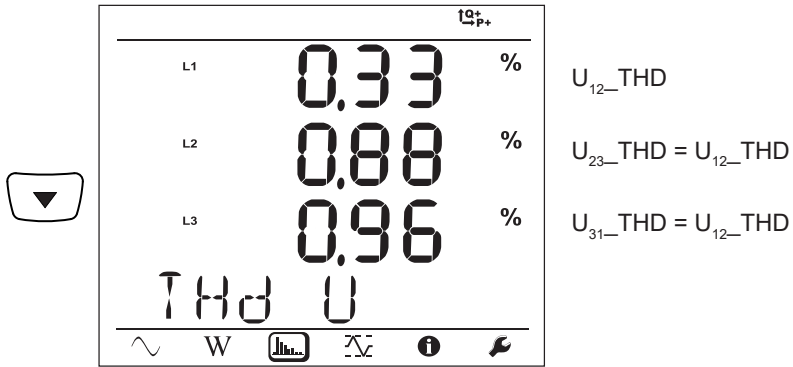

Three-phase, 4-wire, unbalanced (3P-4WY, 3P-4WY2, 3P-4WΔ, 3P-4WO)

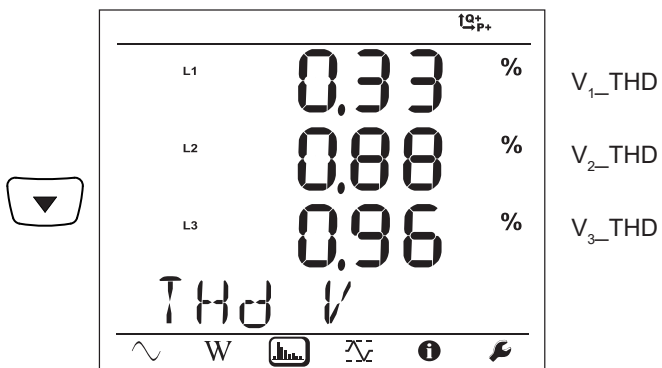
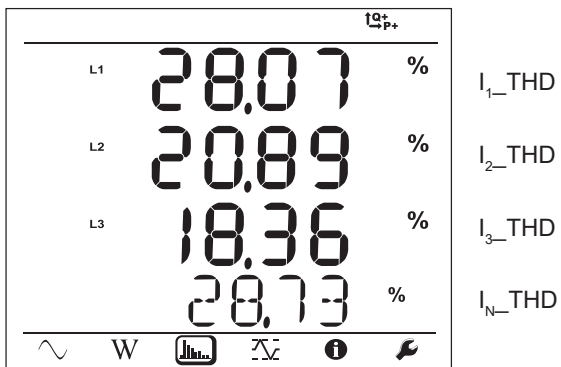

Three-phase, 4-wire, wye, balanced (3P-4WYb)

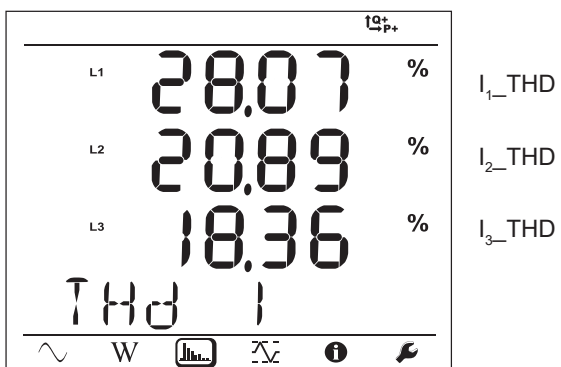

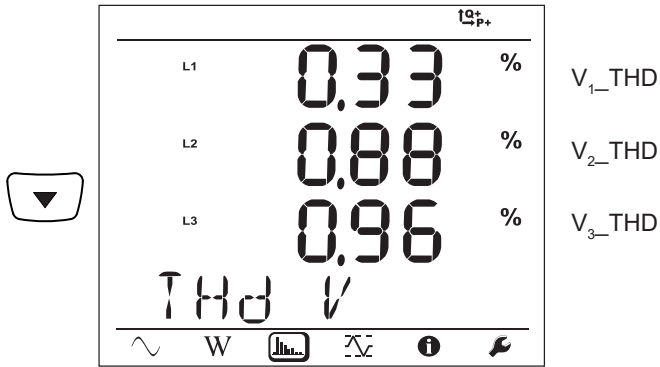

V_{1_THD}

V_{2_THD}

V_{3_THD}

4.3.4. MAXIMUM MODE

Depending on the option selected in PEL Transfer, these may be the maximum aggregated values of the recording in progress or of the last record, or the maximum aggregated values since the last reset.

The maximum display is not available for DC networks. The display unit indicates "No Max in DC Mode".

Single-phase, 2-wire (1P-2W)

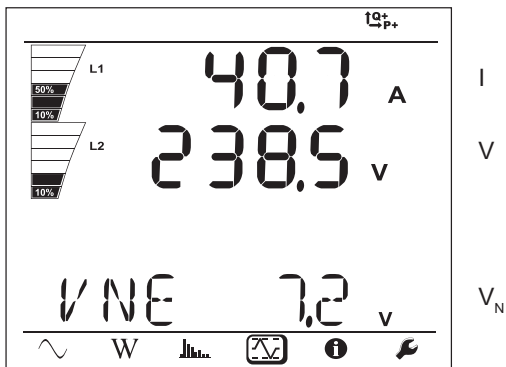

I

V

V_N

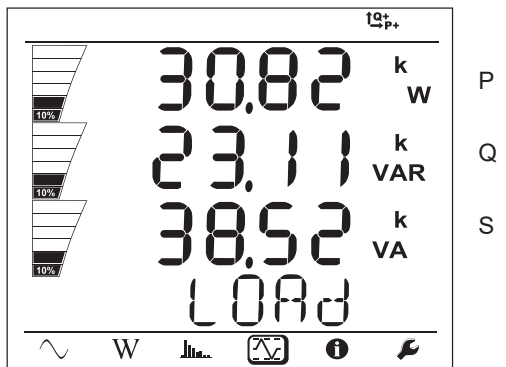

P

Q

S

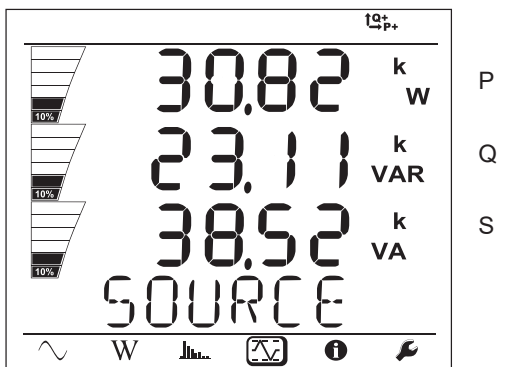

P

Q

S

Two-phase, 3-wire (1P-3W)

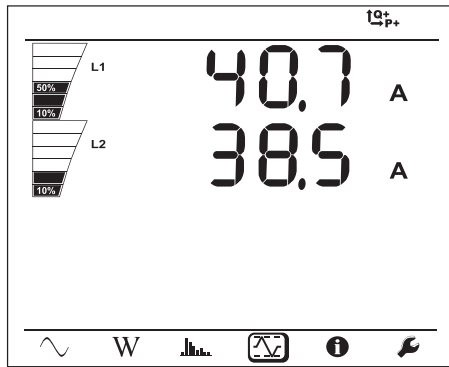

I_1

I_2

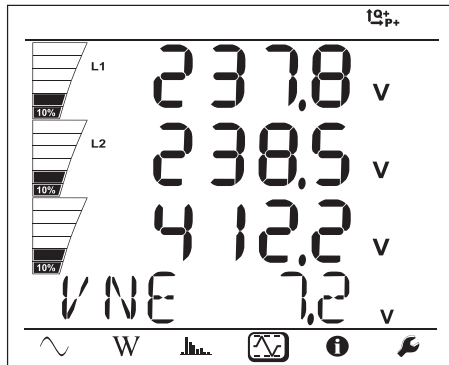

V_1

V_2

U_{12}

V_N

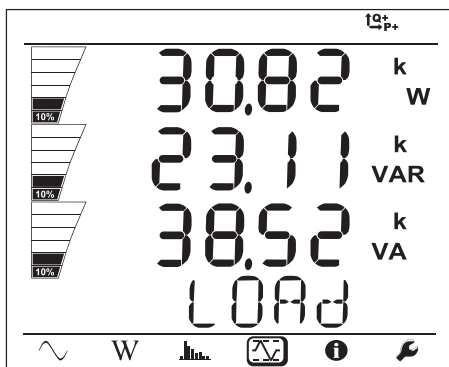

P

Q

S

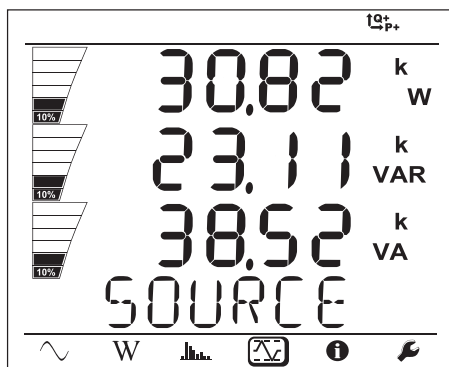

P

Q

S

Three-phase, 3-wire (3P-3WΔ2, 3P-3WΔ3, 3P-3WO2, 3P-3WO3, 3P-3WY2, 3P-3WY3, 3P-3WΔb)

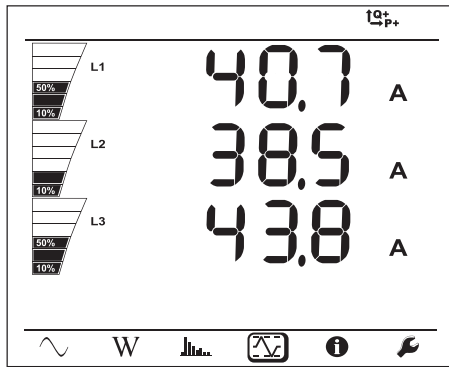

I_1

I_2

I_3

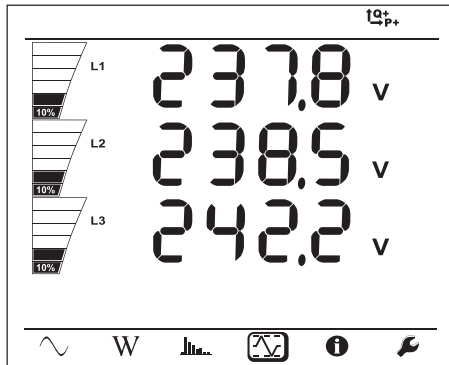

U_{12}

U_{23}

U_{31}

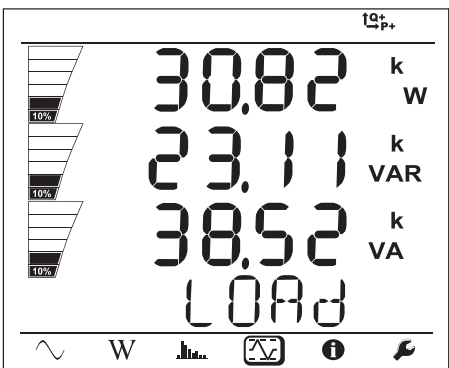

P

Q

S

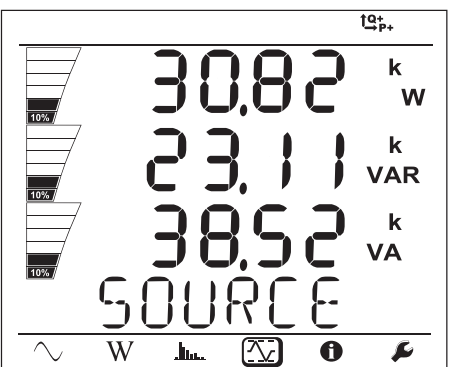

P

Q

S

Three-phase, 4-wire (3P-4WY, 3P-4WY2, 3P-4WΔ, 3P-4WO), 3P-4WYb)

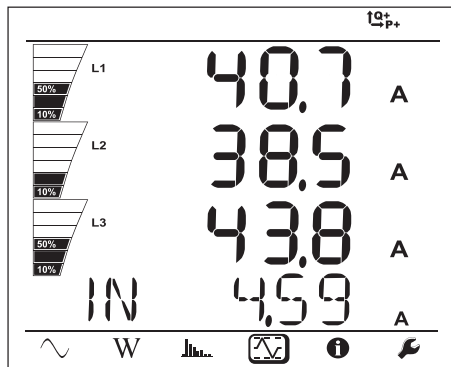

For the balanced network (3p-4WYb), I_N is not displayed.

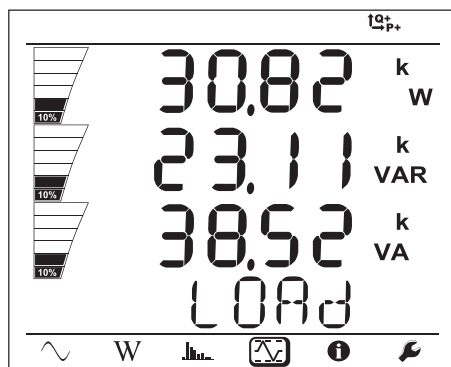
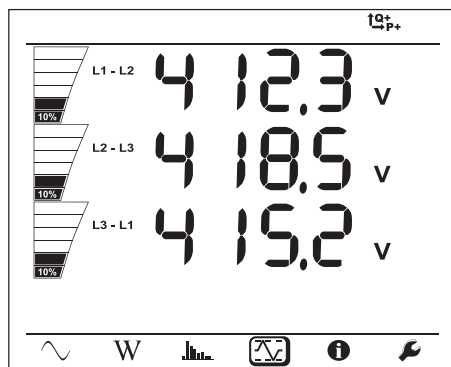
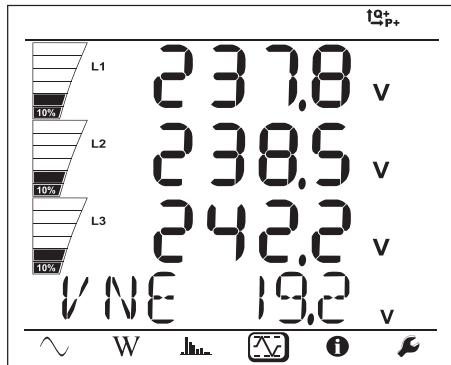

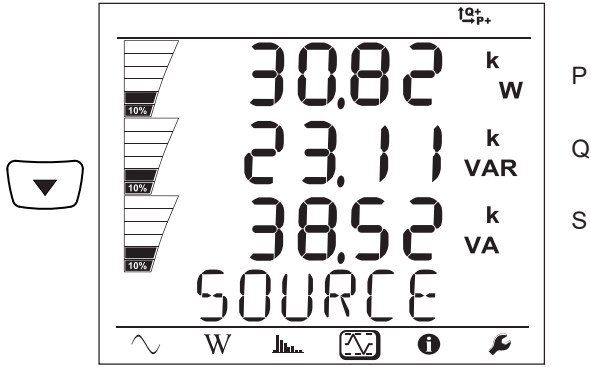

5. SOFTWARE AND APPLICATION

5.1. PEL TRANSFER SOFTWARE

5.1.1. FUNCTIONS

PEL transfer software is used to:

- Connect the instrument to the PC by Wi-Fi, USB or Ethernet.
- Assign a name to the instrument, choose the brightness and contrast of the display unit, disable or enable the **Selection** key of the instrument, set the date and time, format the SD card, etc.
- Configure communication between the instrument and the PC.
- Configure the measurement: choose the distribution network, the transformation ratio, the frequency, the transformation ratios of the current sensors.
- Configure the records: choose their names, their duration, their starting and ending dates, the aggregation period, whether or not "1s" values and harmonics are recorded.
- Manage energy meters, the operating time of the instrument, the time voltages are present on the measurement inputs, the time currents are present on the measurement inputs, etc.
- Manage the sending of periodic reports by email.

PEL Transfer can also be used to open records, upload them to the PC, export them to a spreadsheet, view the corresponding curves, and create and print reports.

It is also used to update the internal software of the instrument when a new update is available.

5.1.2. INSTALLING PEL TRANSFER



Do not connect the instrument to the PC until the software and the driver have been installed.

1. Download the latest version of PEL Transfer from our web site:

www.chauvin-arnoux.com

Run **setup.exe**. Then follow the installation instructions.



You must have administrator privileges on your PC to install the PEL Transfer software.

2. A warning message like the one shown below appears. Click on **OK**.

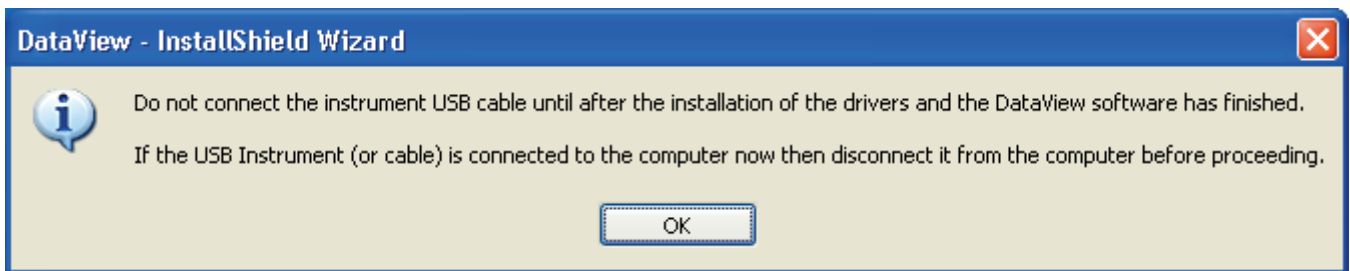

Figure 34



Installing the driver may take some time. Windows may even indicate that the program is no longer responding, even though it is in fact running. Wait for it to terminate.

3. When the driver has been installed, the **Installation succeeded** dialogue box is displayed. Click on **OK**.
4. The **Install Shield Wizard terminated** window is then displayed. Click on **Terminate**.
5. A **Question** dialogue box opens. Click on **Yes** to read the procedure for connecting the instrument to the USB port of the computer.



The browser window remains open. You can select another option to download (for example Adobe® Reader), or user manuals to read, or close the window.

6. If necessary, reboot the computer.



A shortcut has been added to your desktop or in the DataView directory.

You can now open PEL Transfer and connect your PEL to the computer.



For context-sensitive information about the use of PEL Transfer, refer to the Help menu of the software.

5.2. PEL APPLICATION

The Android application provides some of the functions of the PEL Transfer software. It enables you to connect to your instrument remotely.

Find the application by typing PEL Chauvin Arnoux. Install the application on your smartphone or tablet.

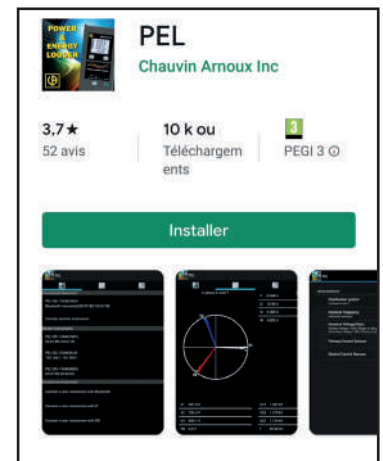

The application has 3 tabs.



is used to connect the instrument:

- or by Ethernet. Connect your instrument to the Ethernet network using a cable, then enter its IP address (see §3.6), the port, and the network protocol (this information is available in PEL Transfer). Then log in.
- or by IRD server (DataViewSync™). Enter the serial number of the PEL (see §3.6) and the password (this information is available in PEL Transfer). Then connect.



is used to display the measurements in the form of a Fresnel diagram.

Drag the screen to the left to see the voltage, current, power, and energy values and motor information (speed of rotation, torque), etc.



is used to:

- Configure the records: choose their names, their duration, their start and end dates, the aggregation period, whether or not the “1s” values and harmonics are recorded.
- Configure the measurement: choose the distribution network, the transformation ratio, the frequency, the transformation ratios of the current sensors.
- Configure communication between the instrument and the smartphone or tablet.

Configure the instrument: set the date and time, format the SD card, lock or unlock the **Selection**  key, enter the motor information, and display the information on the instrument.

6. TECHNICAL CHARACTERISTICS

Uncertainties are expressed as a percentage (%) of the reading (R) plus an offset:
 $\pm (a\%R + b)$

6.1. REFERENCE CONDITIONS

Parameter	Reference conditions
Ambient temperature	23 ± 2 °C
Relative humidity	45% RH to 75% RH
Voltage	No DC component in the AC, no AC component in the DC (< 0.1%)
Current	No DC component in the AC, no AC component in the DC (< 0.1%)
Network frequency	50Hz ± 0.1Hz and 60Hz ± 0.1Hz
Voltage-current phase difference	0° (active power) or 90° (reactive power)
Harmonics	< 0.1%
Voltage unbalance	0%
Warming up	The instrument must have been on for at least one hour.
Common mode	The instrument is powered by the battery; the USB is disconnected.
Magnetic field	0 AAc/m
Electric field	0 VAc/m

Table 6

6.2. ELECTRICAL CHARACTERISTICS

6.2.1. VOLTAGE INPUTS

Range of operation: up to 1,000 VRMS for phase-neutral voltages, voltages between phases, and the neutral-earth voltage, from 42.5 to 69 Hz (600 VRMS from 340 to 460 Hz) and up to 1,000 Vdc.



Phase-neutral voltages below 2 V and voltages between phases below $2\sqrt{3}$ V are set to zero.

Input impedance: 1,908 kΩ (phase-neutral and neutral-earth)

Maximum overload: 1,100 VRMS

6.2.2. CURRENT INPUTS



The outputs of the current sensors are voltages.

Range of operation: 5 μV to 1.2 V (1 V = Inom) with a crest factor = $\sqrt{2}$

Input impedance: 1 MΩ (except AmpFlex® / MiniFlex current sensors):
 12.4 kΩ (current sensors AmpFlex® / MiniFlex)

Maximum overload: 1.7 V

6.2.3. INTRINSIC UNCERTAINTY (NOT COUNTING THE CURRENT SENSORS)

The uncertainties in the tables below are given for the "1s" and aggregated values. For the "200ms" measurements, the uncertainties must be doubled

6.2.3.1. Specifications at 50/60Hz

Quantities	Measurement range	Intrinsic uncertainty
Frequency (f)	[42.5; 69Hz]	$\pm 0.1\text{Hz}$
Phase-neutral voltage (V)	[10V; 1,000V]	$\pm 0.2\% R \pm 0.2 V$
Neutral-earth voltage (V_{PE})	[10V; 1,000V]	$\pm 0.2\% R \pm 0,2 V$
Phase-phase voltage (U)	[17 V; 1,700 V]	$\pm 0.2\% R \pm 0,4 V$
Current (I)	[0.2% Inom; 120% Inom]	$\pm 0.2\% R \pm 0.02\% \text{Inom}$
Neutral current (I_N)	[0.2% Inom; 120% Inom]	$\pm 0.2\% R \pm 0.02\% \text{Inom}$
Active power (P) kW	PF = 1 V = [100V; 1,000V] I = [5% Inom; 120% Inom]	$\pm 0.5\% R \pm 0.005\% \text{Pnom}$
	PF = [0.5 inductive; 0.8 capacitive] V = [100V; 1,000V] I = [5% Inom; 120% Inom]	$\pm 0.7\% R \pm 0.007\% \text{Pnom}$
Reactive power (Q) kvar	Sin ϕ = 1 V = [100V; 1,000V] I = [5% Inom; 120% Inom]	$\pm 1\% R \pm 0.01\% \text{Qnom}$
	Sin ϕ = [0.5 inductive; 0.5 capacitive] V = [100V; 1,000V] I = [5% Inom; 120% Inom]	$\pm 1.5\% R \pm 0.01\% \text{Qnom}$
	Sin ϕ = [0,5 inductive; 0,5 capacitive] V = [100V; 1,000V] I = [5% Inom; 120% Inom]	$\pm 3.5\% R \pm 0.03\% \text{Qnom}$
	Sin ϕ = [0.25 inductive; 0.25 capacitive] V = [100V; 1,000V] I = [10% Inom; 120% Inom]	$\pm 1.5\% R \pm 0.015\% \text{Qnom}$
Apparent power (S) kVA	V = [100V; 1,000V] I = [5% Inom; 120% Inom]	$\pm 0.5\% R \pm 0.005\% \text{Snom}$
Power factor (PF)	PF = [0.5 inductive; 0.5 capacitive] V = [100V; 1,000V] I = [5% Inom; 120% Inom]	± 0.05
	PF = [0.2 inductive; 0.2 capacitive] V = [100V; 1,000V] I = [5% Inom; 120% Inom]	± 0.1
tan Φ	tan Φ = [$\sqrt{3}$ inductive; $\sqrt{3}$ capacitive] V = [100 V; 1,000 V] I = [5% Inom; 120% Inom]	± 0.02
	tan Φ = [3.2 inductive; 3.2 capacitive] V = [100V; 1,000V] I = [5% Inom; 120% Inom]	± 0.05
Active energy (Ep) kWh	PF = 1 V = [100V; 1,000V] I = [5% Inom; 120% Inom]	$\pm 0.5\% R$
	PF = [0.5 inductive; 0.8 capacitive] V = [100V; 1,000V] I = [10% Inom; 120% Inom]	$\pm 0.7\% R$
Reactive energy (Eq) kvarh	Sin ϕ = 1 V = [100V; 1,000V] I = [5% Inom; 120% Inom]	$\pm 1.5\% R$
	Sin ϕ = [0.5 inductive; 0.5 capacitive] V = [100V; 1,000V] I = [5% Inom; 120% Inom]	$\pm 2\% R$
Apparent energy (Es) kVAh	V = [100V; 1,000V] I = [5% Inom; 120% Inom]	$\pm 0.5\% R$

Quantities	Measurement range	Intrinsic uncertainty
THD %	PF = 1 V = [100V; 1,000V] I = [10 % Inom; 120% Inom]	± 1% R

Table 7

- *Inom* is the measured current when the output from the current sensor is 1V.
- *Pnom* and *Snom* are the active and apparent powers for $V = 1,000\text{ V}$, $I = I_{nom}$, and $PF = 1$.
- *Qnom* is the reactive power for $V = 1,000\text{ V}$, $I = I_{nom}$, and $\sin \varphi = 1$.
- The intrinsic uncertainty of the current inputs is specified for an isolated voltage input of 1V, corresponding to *Inom*. The intrinsic uncertainty of the current sensor used must be added to it to determine the total uncertainty of the measurement system. With the AmpFlex® and MiniFlex current sensors, the intrinsic uncertainty given in Table 21 must be used.
- If there is no current sensor, the intrinsic uncertainty on the neutral current is the sum of the intrinsic uncertainties on I1, I2, and I3.

6.2.3.2. Specifications at 400Hz

Quantities	Measurement range	Intrinsic uncertainty
Frequency (f)	[340 Hz; 460 Hz]	± 0.3 Hz
Phase-neutral voltage (V)	[10 V; 600 V]	± 0.2% R ± 0.5 V
Neutral-earth voltage (V_{PE})	[4 V; 600 V]	± 0.2% R ± 0.5 V
Phase-phase voltage (U)	[17 V; 600 V]	± 0.2% R ± 1 V
Current (I)	[0.2% Inom; 120% Inom]	± 0.5% R ± 0.05% Inom
Neutral current (I_N)	[0.2% Inom; 120% Inom]	± 0.5% R ± 0.05% Inom
Active power (P) kW	PF = 1 V = [100V; 600 V] I = [5% Inom; 120% Inom]	±2% R ± 0.02% Pnom ¹
	PF = [0.5 inductive; 0.8 capacitive] V = [100V; 600 V] I = [5% Inom; 120% Inom]	±3% R ± 0.03% Pnom ¹
Active energy (Ep) kWh	PF = 1 V = [100V; 600 V] I = [5% Inom; 120% Inom]	± 2% R

Table 8

- *Inom* is the measured current when the output from the current sensor is 1V.
- *Pnom* is the active power for $V = 600\text{ V}$, $I = I_{nom}$, and $PF = 1$.
- The intrinsic uncertainty of the current inputs is specified for an isolated voltage input of 1V, corresponding to *Inom*. The intrinsic uncertainty of the current sensor used must be added to it to determine the total uncertainty of the measurement system. With the AmpFlex® and MiniFlex current sensors, the intrinsic uncertainty given in Table 21 must be used.
- If there is no current sensor, the intrinsic uncertainty on the neutral current is the sum of the intrinsic uncertainties on I1, I2, and I3.
- With the AmpFlex® and MiniFlex current sensors, the maximum current is limited to 60% *Inom* at 50/60Hz.
- 1: Value given for guidance.

6.2.3.3. Specifications in DC

Quantities	Measurement range	Typical intrinsic uncertainty
Voltage (V)	V = [100V; 1,000 V]	± 0.2% R ± 0.2 V
Neutral-earth voltage (V_{PE})	V = [2 V; 1,000 V]	± 0.2% R ± 0.2 V
Current (I)	I = [5% Inom; 120% Inom]	± 0.2% R ± 0.02% Inom
Neutral current (I_N)	I = [5% Inom; 120% Inom]	± 0.2% R ± 0.02% Inom
Power (P) kW	V = [100 V; 1,000 V] I = [5% Inom; 120% Inom]	± 0.5% R ± 0.005% Pnom
Energy (Ep) kWh	V = [100 V; 1,000 V] I = [5% Inom; 120% Inom]	± 1% R

Table 9

- *Inom* is the measured current when the output from the current sensor is 1V.
- *Pnom* is the active power for V = 600 V, I = *Inom*
- The intrinsic uncertainty of the current inputs is specified for an isolated voltage input of 1V, corresponding to *Inom*. The intrinsic uncertainty of the current sensor used must be added to it to determine the total uncertainty of the measurement system.
- If there is no current sensor, the intrinsic uncertainty on the neutral current is the sum of the intrinsic uncertainties on I1, I2, and I3.

6.2.3.4. Temperature

For V, U, I, P, Q, S, PF and E:

- 300ppm/°C, with 5% < I < 120% and PF = 1
- 500ppm/°C, with 10% < I < 120% and PF = 0.5 inductive

Offset in DC

- V: 10mV/°C typical
- I: 30ppm x *Inom* /°C typical

6.2.3.5. Common mode rejection

The common mode rejection on the neutral is 140 dB typical.

For example, a voltage of 230V applied to the neutral will add 23µV to the output of the AmpFlex® and MiniFlex current sensors, which amounts to an error of 230mA at 50Hz. On the other current sensors, it will amount to an additional error of 0.01% *Inom*.

6.2.3.6. Influence of the magnetic field

On current inputs to which MiniFlex or AmpFlex® flexible current sensors are connected: 10 mA/A/m typical at 50/60Hz.

6.2.4. CURRENT SENSORS

6.2.4.1. Precautions for use

 Refer to the safety data sheet or user manual provided with your current sensors.

Current clamps and flexible current sensors make it possible to measure the current flowing in a cable without opening the circuit. They also isolate the user from the dangerous voltages in the circuit.

Which current sensor to use will depend on the current to be measured and the diameter of the cables.

When you install current sensors, have the arrow on the sensor point toward the load.

Only the AmpFlex® A196A current sensors, the MiniFlex MA196 current sensors and the lockable voltage leads ensure tightness (IP67 when the instrument is closed).

6.2.4.2. Characteristics

The measurement ranges are those of the current sensors. These are sometimes different from those of the PEL. Refer to the user manual provided with the current sensor.

a) AmpFlex® A196A or AmpFlex® A193

- Press on both sides of the opening device to unlock the flexible coil. Open it, then place it around the conductor carrying the current to be measured (only one conductor per coil).

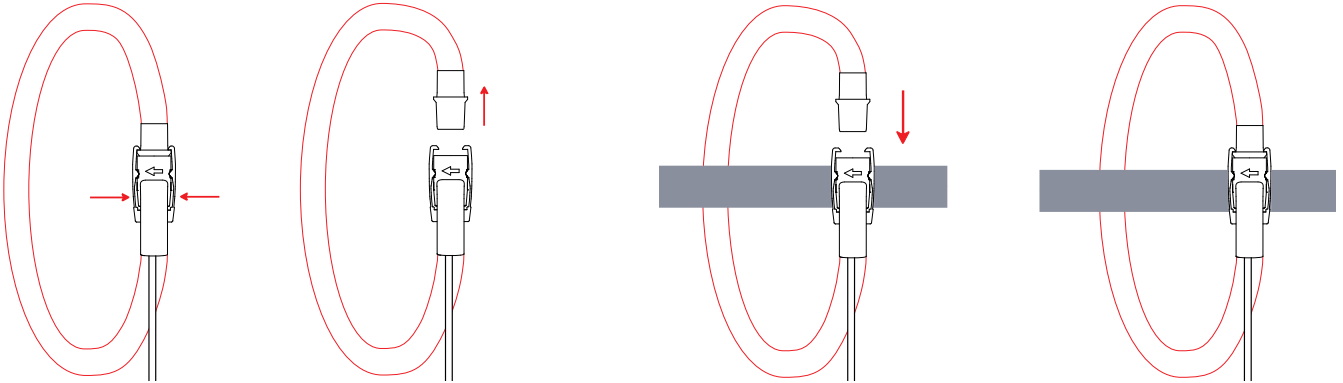

Figure 35

- Close the coil. You must hear it "click". For better measurement quality, centre the conductor in the coil and keep the coil as circular as possible.
- To disconnect the current sensor, open it and withdraw it from the conductor. Then disconnect the current sensor from the instrument.

AmpFlex® A196A (tight, IP67) and AmpFlex® A193	
Nominal range	100 / 400 / 2,000 / 10,000 Aac
Measurement range	0.2 to 12,000 Aac
Maximum clamping diameter (depending on model)	A196A: Length = 610 mm; Ø = 170 mm A193: Length = 450 mm; Ø = 120 mm A193: Length = 800 mm; Ø = 235 mm
Influence of the position of the conductor in the sensor	≤ 2 % everywhere and ≤ 4 % near of snap
Influence of an adjacent conductor carrying an AC current	> 40 dB everywhere and > 33 dB near of snap
Safety	IEC 61010-2-032, degree of pollution 2, 1,000V CAT IV

Table 10

Remark: Currents < 0.05 % of the nominal range will be set to zero.
The nominal ranges are reduced to 50/200/1,000/5,000Aac at 400Hz.

b) MiniFlex MA196

MiniFlex MA196		
Nominal range	100 / 400 / 2,000 Aac	
Measurement range	200 mA to 2,400 Aac	
Maximum clamping diameter	Length = 250 mm; Ø = 70 mm (MA 193 only) Length = 350 mm; Ø = 100 mm	
Influence of the position of the conductor in the sensor	≤ 1.5% typical, 2.5% maximum	
Influence of an adjacent conductor carrying an AC current	> 40 dB typical at 50/60 Hz for a conductor touching the sensor and > 33 dB near the snap	
Safety	IEC 61010-2-032, degree of pollution 2, 600V CAT IV, 1,000V CAT III	

Table 11

Remark: Currents < 0.05 % of the nominal range will be set to zero.
The nominal ranges are reduced to 50/200/1,000/5,000 Aac at 400 Hz.

c) MiniFlex MA194

MiniFlex MA194		
Nominal range	100 / 400 / 2 000 / 10 000Aac (for the 1000 mm model)	
Measurement range	50 mA to 2,400 Aac	
Maximum clamping diameter	Length = 250 mm; Ø = 70 mm Length = 350 mm; Ø = 100 mm Length = 1 000 mm, Ø = 320 mm	
Influence of the position of the conductor in the sensor	≤ 2,5 %	
Influence of an adjacent conductor carrying an AC current	> 40 dB typical at 50/60 Hz for a conductor touching the sensor and > 33 dB near the snap	
Safety	IEC 61010-2-032, degree of pollution 2, 600V CAT IV, 1,000V CAT III	

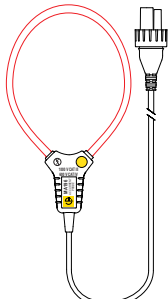
Table 12

Remark: Currents < 0.05 % of the nominal range will be set to zero.
The nominal ranges are reduced to 50/200/1,000/5,000 Aac at 400Hz.
The 10,000A range operates provided that the conductor can be clamped in the MiniFlex sensor.

d) PAC93 clamp

Remark: The power calculations are set to zero while the current zero is adjusted.

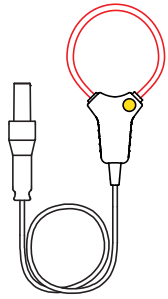
PAC93 clamp		
Nominal range	1,000 Aac, 1,300 Adc	
Measurement range	1 to 1,000 Aac, 1 to 1,300 APEAK AC+DC	
Maximum clamping diameter	One 42mm conductor or two 25.4mm conductors, or two 50 x 5mm bus bars	
Influence of the position of the conductor in the clamp	> 40 dB typical at 50/60 Hz	
Influence of an adjacent conductor carrying an AC current	> 40 dB at 50/60Hz	
Safety	IEC 61010-2-032, degree of pollution 2, 300 V CAT IV, 600 V CAT III	

Table 13

Remark: Currents < 1 Aac/Dc will be set to zero in AC networks.

e) C193 clamp

C193 clamp		
Nominal range	1,000 AAC for $f \leq 10$ kHz	
Measurement range	1A to 1,200 AAC max ($I > 1,000A$ for 5 minutes at most)	
Maximum clamping diameter	52 mm	
Influence of the position of the conductor in the clamp	< 0.5%, from DC to 440 Hz	
Influence of an adjacent conductor carrying an AC current	> 40 dB typical at 50/60 Hz	
Safety	IEC 61010-2-032, degree of pollution 2, 600 V CAT IV, 1,000 V CAT III	

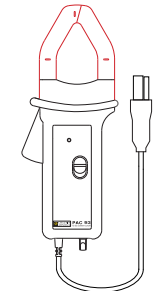
Table 14

Remark: Currents < 0.5A will be set to zero.

f) PMN93 clamp

MN93 clamp		
Nominal range	200 AAC for $f \leq 10$ kHz	
Measurement range	0.5 at 240 AAC max ($I > 200$ A non-permanent)	
Maximum clamping diameter	20 mm	
Influence of the position of the conductor in the clamp	< 0.5%, at 50/60Hz	
Influence of an adjacent conductor carrying an AC current	> 35 dB typical at 50/60 Hz	
Safety	IEC 61010-2-032, degree of pollution 2, 300 V CAT IV, 600 V CAT III	

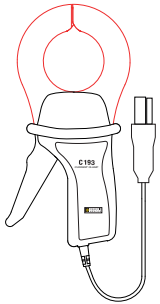
Table 15

Remark: Currents < 100mA will be set to zero.

g) MN93A clamp

MN93A clamp		
Nominal range	5 A and 100 AAC	
Measurement range	5 A range: 0.005 to 6 AAC max 100 A range: 0.2 to 120 AAC max	
Maximum clamping diameter	20 mm	
Influence of the position of the conductor in the clamp	< 0.5%, at 50/60Hz	
Influence of an adjacent conductor carrying an AC current	> 35 dB typical at 50/60 Hz	
Safety	IEC 61010-2-032, degree of pollution 2, 300 V CAT IV, 600 V CAT III	

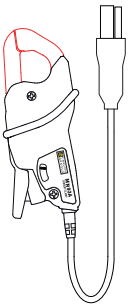
Table 16

The 5A range of MN93A clamps is suited to secondary current measurements on current transformers.

Remark: Currents < 2.5mA × ratio in the 5A range and < 50mA in the 100A range will be set to zero.

h) E94 clamp with adapter

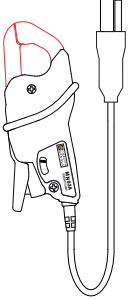
E94 clamp		
Nominal range	10 AAC/DC, 100 AAC/DC	
Measurement range	100 mV/A range: 0.05 o 10 AAC/DC 10 mV/A range: 0.5 o 100 AAC/DC	
Maximum clamping diameter	11.8 mm	
Influence of the position of the conductor in the clamp	< 0.5%	
Influence of an adjacent conductor carrying an AC current	> 33 dB typical, from DC to 1kHz	
Safety	IEC 61010-2-032, degree of pollution 2, 300 V CAT IV, 600 V CAT III	

Table 17

Remark: Currents < 50mA will be set to zero in AC networks

i) J93 clamps

J93 clamps		
Nominal range	3,500 AAC, 5,000 Adc	
Measurement range	50 - 3,500 AAC; 50 - 5,000 Adc	
Maximum clamping diameter	72 mm	
Influence of the position of the conductor in the clamp	< ± 2%	
Influence of an adjacent conductor carrying an AC current	> 35 dB typical, from DC to 2 kHz	
Safety	IEC 61010-2-032, degree of pollution 2, 600 V CAT IV, 1,000 V CAT III	

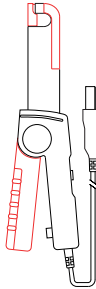
Table 18

Remark: Currents < 5 A will be set to zero in AC networks

j) 5A adapter unit and Essailec®

5A adapter unit and Essailec®		
Nominal range	5 AAC	
Measurement range	0.005 to 6 AAC	
Number of inputs for transformer	3	
Safety	IEC 61010-2-030, degree of pollution 2, 300V CAT III	

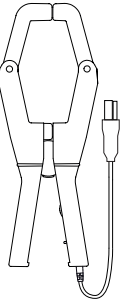
Table 19

Remark: Currents < 2.5 mA will be set to zero.

6.2.4.3. Intrinsic uncertainty

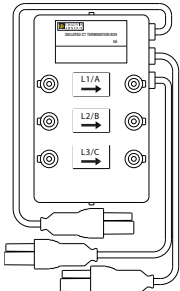

The intrinsic uncertainties of the current measurements and of the phase must be added to the intrinsic uncertainties of the instrument for the quantity concerned: power, energies, power factors, tan Φ , etc.

The following characteristics are given for the reference conditions of the current sensors.

Characteristics of the current sensors (output 1V at I_{nom})

Current sensor	I nominal	Current (RMS or DC)	Intrinsic uncertainty at 50/ 60Hz	Intrinsic uncertainty on φ at 50/60 Hz	Typical uncertainty on φ at 50/60Hz	Typical uncertainty on φ at 400 Hz
PAC193 clamps	1,000 AAC 1,300ADC	[1A; 50A[$\pm 1.5\% R \pm 1 A$	-	-	- 4.5°@ 100A
		[50 A; 100 A[$\pm 1.5\% R \pm 1 A$	$\pm 2.5^\circ$	-0.9°	
		[100 A; 800 A[$\pm 2.5\% R$	$\pm 2^\circ$	- 0.8°	
		[800 A; 1,000 A[$\pm 4\% R$		- 0.65°	
]1,000 Adc; 1,300 Adc[$\pm 4\% R$		- 0.65°	
C193 clamps	1,000 AAC	[1 A; 50 A[$\pm 1\% R$	-	-	+ 0.1°@ 1,000A
		[50 A; 100 A[$\pm 0.5\% R$	$\pm 1^\circ$	+ 0.25°	
		[100 A; 1,200 A[$\pm 0.3\% R$	$\pm 0.7^\circ$	+ 0.2°	
MN93 clamps	200 AAC	[0.5 A; 5 A[$\pm 3\% R \pm 1 A$	-	-	-
		[5 A; 40 A[$\pm 2.5\% R \pm 1 A$	$\pm 5^\circ$	+ 2°	- 1.5°@ 40 A
		[40 A; 100 A[$\pm 2\% R \pm 1 A$	$\pm 3^\circ$	+ 1.2°	- 0.8°@ 100A
		[100 A; 240 A[$\pm 1\% R + 1A$	$\pm 2.5^\circ$	$\pm 0.8^\circ$	- 1°@ 200 A
MN93A clamps	100 AAC	[200 mA; 5 A[$\pm 1\% R \pm 2 mA$	$\pm 4^\circ$	-	-
		[5 A; 120 A[$\pm 1\% R$	$\pm 2.5^\circ$	+ 0.75°	- 0.5°@100A
	5 AAC	[5 mA; 250 mA[$\pm 1.5\% R \pm 0.1 mA$	-	-	-
		[250 mA; 6 A[$\pm 1\% R$	$\pm 5^\circ$	+ 1.7°	- 0.5°@ 5 A
E94 clamps	100AAC/DC	[50 mA; 40 A[$\pm 4\% R \pm 50 mA$	$\pm 1^\circ$	-	-
		[40 A; 100 A[$\pm 15\% R$	$\pm 1^\circ$	-	-
	10 AAC/DC	[50 mA; 10 A[$\pm 3\% R \pm 50 mA$	$\pm 1.5^\circ$	-	-
J93 clamps	3,500 AAC 5,000 ADC	[50 A; 250 A[$\pm 2\% R \pm 2.5 A$	$\pm 3^\circ$	-	-
		[250 A; 500 A[$\pm 1.5\% R \pm 2.5 A$	$\pm 2^\circ$	-	-
		[500 A; 3,500 A[$\pm 1\% R$	$\pm 1.5^\circ$	-	-
]3,500 Adc; 5,000 Adc[$\pm 1\% R$	-	-	-
Adapter 5A/ Essallec®	5 AAC	[5 mA; 250 mA[$\pm 0.5\% R \pm 2 mA$	$\pm 0.5^\circ$	-	-
		[250 mA; 6 A[$\pm 0.5\% R \pm 1 mA$	$\pm 0.5^\circ$		

Table 20

Characteristics of the AmpFlex® and MiniFlex

Current sensor	I nominal	Current (RMS or DC)	Intrinsic uncertainty at 50/60Hz	Intrinsic uncertainty at 400Hz	Intrinsic uncertainty on φ at 50/60 Hz	Typical uncertainty on φ at 400 Hz
AmpFlex® A196A A193	100 AAC	[200 mA; 5 A[± 1.2% R ± 50mA	± 2 % R ± 0.1 A	-	-
		[5 A; 120 A[*			± 0.5°	- 0.5°
	400 AAC	[0.8 A; 20 A[± 1.2% R ± 0.2 A	± 2 % R ± 0.4 A	-	-
		[20 A; 500 A[*			± 0.5°	- 0.5°
	2,000 AAC	[4 A; 100 A[± 1.2 % R ± 1 A	± 2 % R ± 2 A	-	-
		[100 A; 2,400 A[*			± 0.5°	- 0.5°
	10,000 AAC	[20 A; 500 A[± 1.2 % R ± 5 A	± 2% R ± 10A	-	-
		[500 A; 12,000 A[*			± 0.5°	- 0.5°
MiniFlex MA196 MA194	100 AAC	[200 mA; 5 A[± 1 % R ± 50mA	± 2 % R ± 0.1 A	-	-
		[5 A; 120 A[*			± 0.5°	- 0.5°
	400 AAC	[0.8 A; 20 A[± 1 % R ± 0.2 A	± 2 % R ± 0.4 A	-	-
		[20 A; 500 A[*			± 0.5°	- 0.5°
	2,000 AAC	[4 A; 100 A[± 1 % R ± 1 A	± 2 % R ± 2 A	-	-
		[100 A; 2,400 A[*			± 0.5°	- 0.5°
	10,000AAC ¹	[20 A; 500 A[± 1 % R ± 1 A	± 2 % R ± 2 A	-	-
		[500 A; 12,000 A[*			± 0.5°	- 0.5°

Table 21

1: Provided that the conductor can be clamped.

 The nominal ranges are halved at 400Hz (*).

Limits of the AmpFlex® and MiniFlex

Like all Rogowski probes, the AmpFlex® and MiniFlex deliver output voltages proportional to the frequency. A high current at a high frequency can saturate the current inputs of the devices.

To avoid saturation, the following condition must be satisfied:

$$\sum_{n=1}^{n=\infty} [n \cdot I_n] < I_{nom}$$

Where I_{nom} is the range of the current sensor
 n is the order of the harmonic
 I_n is the current of the harmonic of order n

For example, the input current range of a dimmer must not exceed one fifth of the current range selected on the device.

This requirement does not take into account the limitation of the pass band of the device, which may lead to other errors.

6.3. COMMUNICATION

6.3.1. USB

Type B connector
USB 2

6.3.2. NETWORK

RJ45 connector with 2 built-in LEDs
100 Base T Ethernet

6.3.3. WI-FI

2.4 GHz band, IEEE 802.11 B/G/N radio
TX power: +17 dBm
RX sensitivity: -97 dBm
Rate: 72.2 MB/s max
Safety: WPA / WPA2
Access Point (AP): up to five clients

6.4. POWER SUPPLY

Mains supply

- **Range of operation:** 100 V to 1,000 V for a frequency from 42.5 to 69 Hz
100 V to 600 V for a frequency from 340 to 460 Hz
140 V to 1,000 V in DC
- **Maximum power:** 30 VA

PA30W specific external mains power supply unit (optional)

- This is a specific 600 V, category IV – 1000 V, category III
- Range of use: from 90 to 264 VAc @ 50/60 Hz.
- Maximum input power: 65 VA.
- Output voltage: 15 Vdc

Battery

- Type: Rechargeable NiMH battery
- Mass: approximately 200 g
- Number of charging/discharging cycles: > 1,000
- Charging time: Approximately 5h
- Charging temperature: -20 to +55 °C
- Life between charges: approximately 1h without Wi-Fi activated



When the instrument is powered down, the clock is preserved for 20 days.

6.5. MECHANICAL CHARACTERISTICS

- **Dimensions:** 270mm (+50mm with the leads connected) × 245mm × 180mm
- **Mass:** approximately 3.4kg
- **Drop:** 20cm in the worst position without permanent mechanical damage or functional deterioration.
1m in its packaging.
- **Degrees of protection per IEC 60529**
 - IP 67 when the cover of the instrument is closed, the voltage leads are screwed, and the leads of the AmpFlex® A196A are screwed.
 - IP 67 when the cover of the instrument is closed and the plugs on the terminals are in place.
 - IP 54 when the cover is open, the instrument is in a horizontal position, and the plugs on the terminals are in place.
 - IP 40 when the cover is open, the instrument is in a horizontal position, and the plugs are not in place.

6.6. ENVIRONMENTAL CHARACTERISTICS

- Indoor and outdoor use.
- **Altitude:**
 - Operation: 0 to 2,000 m
 - Storage: 0 to 10,000 m
- **Temperature and relative humidity:**

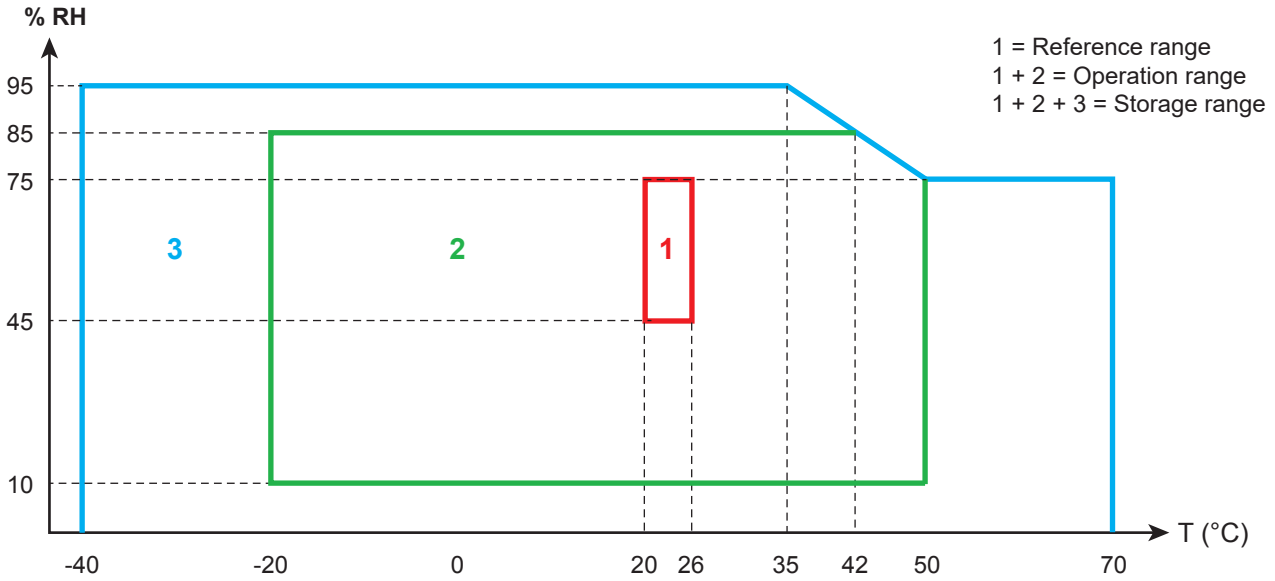

Figure 36

6.7. ELECTRICAL SAFETY

The instruments are compliant with standard IEC/EN 61010-2-030 or BS EN 61010-2-030:

- Measurement inputs and enclosure: 1,000V overvoltage category IV, degree of pollution 3 (4 with instrument closed)
- Power supply: 1,000V overvoltage category IV, pollution degree 2

The current sensors are compliant with standard IEC/EN 61010-2-032 or BS EN 61010-2-032.

The measurement leads and the crocodile clips are compliant with standard IEC/EN 61010-031 or BS EN 61010-031.

6.8. ELECTROMAGNETIC COMPATIBILITY

Emissions and immunity in an industrial environment per IEC/EN 61326-1 or BS EN 61326-1.

With the AmpFlex® and the MiniFlex, the typical influence on the measurement is 0.5% of full scale, with a maximum of 5A.

6.9. RADIO EMISSION

The devices are compliant with the 2014/53/EU RED directive and FCC Regulations.

Wi-Fi: FCC certification QQQWF121

6.10. MEMORY CARD

The PEL accepts FAT32-formatted SD, SDHC and SDXC cards up to a capacity of 32GB. The SDXC cards must be formatted in the instrument.

Number of insertions and withdrawals: 1,000.

The transfer of a large quantity of data may take a long time. Moreover, some computers may have difficulty processing such large quantities of information, and spread sheets accept only a limited quantity of data.

We recommend optimizing the data on the SD card and recording only the necessary measurements. For guidance, a 5-day record, with an aggregation time of 15 minutes, a record of the "1s" data and the harmonics on a three-phase four-wire network occupies approximately 530MB. If the harmonics are not essential and if recording of them is deactivated, the size is reduced to approximately 67MB.

The maximum durations of records for a 2 GB card are the following:

- 19 days for recording with an aggregation time of 1 minute, the "1s" data, and the harmonics;
- 12 weeks for recording with an aggregation time of 1 minute, the "1s" data, but no harmonics;
- 2 years for recording with an aggregation time of 1 minute.

Do not exceed 32 records on the SD card.

For records that are long (duration greater than one week) or include the harmonics, use class 4 or higher SDHC cards.

Do not use the Wi-Fi link to upload large records: it would take too long. If no other link is possible, shrink the record by removing the "1s" data and the harmonics. Without these last, a 30-day record occupies only 2.5MB.

On the other hand, uploading by USB or Ethernet link can be acceptable, depending on the length of the record and the transmission rate.

To transfer the data more rapidly, use the SD card/USB adapter.

7. MAINTENANCE



Except for the attachments of the tight connectors and the caps of the terminals, the instrument contains no parts that can be replaced by personnel who are not specially trained and accredited. Any unauthorized repair or replacement of a part by an “equivalent” may gravely impair safety.

Regularly check the condition of the O-rings in the leads. If they fail, tightness is no longer ensured.

7.1. CLEANING



Disconnect the instrument completely.

Use a soft cloth, dampened with soapy water. Rinse with a damp cloth and dry rapidly with a dry cloth or forced air. Do not use alcohol, solvents, or hydrocarbons.

Do not use the instrument if the terminals or the keypad are wet. Dry it first.

For the current sensors:

- Make sure that no foreign body interferes with the operation of the snap locking device of the current sensor.
- Keep the jaws of the clamp perfectly clean. Do not spray water directly on the clamp.

7.2. BATTERY

The instrument uses a NiMH battery. This technology has several advantages:

- Long life between charges but compact and light;
- Memory effect substantially reduced: you can recharge your battery even if it is not fully discharged;
- Protection of the environment: no pollutants such as lead or cadmium, in accordance with the applicable regulations.

The battery may be fully discharged after prolonged storage. In this case, charging may take several hours. It will then take at least 5 charging/discharging cycles for the battery to recover 95% of its capacity.

To optimize the use of your battery and prolong its useful life:

- Charge the instrument only at temperatures between -20 and +55°C.
- Use as prescribed.
- Store as prescribed.

7.3. UPDATING THE EMBEDDED SOFTWARE

With a view to providing, at all times, the best possible service in terms of performance and technical improvements, Chauvin Arnoux offers you the possibility of updating the internal software of this instrument by downloading, free of charge, the new version available on our web site.

See you on our site:

www.chauvin-arnoux.com

Then go to **Support**, then **Download our software**, then **PEL115**.

Connect the instrument to your PC using the USB cord provided.

The PEL Transfer software informs you when an update is available and makes it easy to install it.



Updating the embedded software may reset the configuration and cause the loss of the recorded data. As a precaution, save the data in memory to a PC before updating the embedded software.

8. WARRANTY

Except as otherwise stated, our warranty is valid for **24 months** starting from the date on which the equipment was sold. The extract from our General Conditions of Sale is available on our website.

www.group.chauvin-arnoux.com/en/general-terms-of-sale

The warranty does not apply in the following cases:

- Inappropriate use of the equipment or use with incompatible equipment;
- Modifications made to the equipment without the explicit permission of the manufacturer's technical staff;
- Work done on the device by a person not approved by the manufacturer;
- Adaptation to a particular application not anticipated in the definition of the equipment or not indicated in the user's manual;
- Damage caused by shocks, falls, or floods.

9. APPENDIX

9.1. MEASUREMENTS

9.1.1. DEFINITION

The calculations are performed in accordance with standards IEC 61557-12, IEC 61000-4-30, and IEEE 1459.

Geometrical representation of the active and reactive powers:

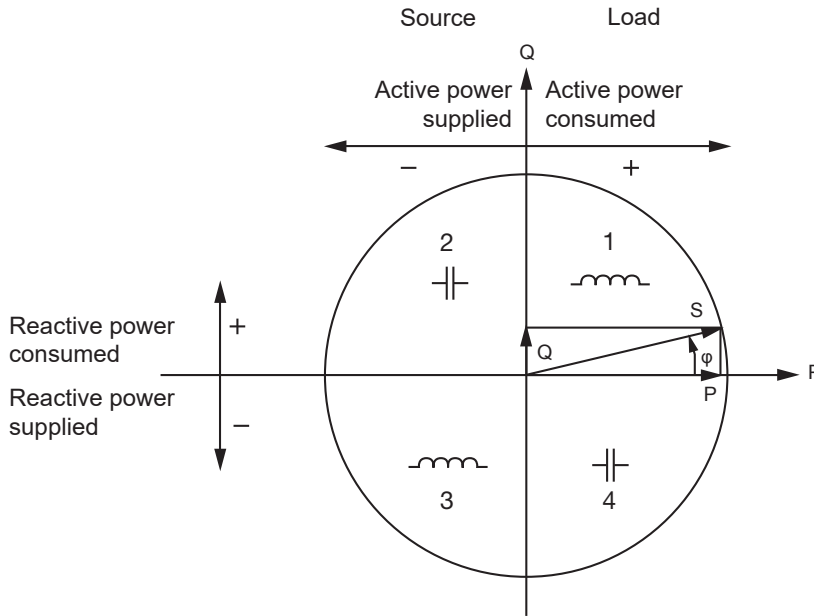

Figure 37

The quadrants are given for the fundamental power values.

The reference of this diagram is the current vector (fixed on the right-hand part of the axis).

Voltage vector V varies in direction according to phase angle φ .

The phase angle φ , between the voltage V and the current I , is considered positive in the anticlockwise direction.

9.1.2. SAMPLING

9.1.2.1. Sampling period

This depends on the network frequency: 50, 60 or 400Hz.

The sampling period is calculated every second.

- Network frequency $f = 50\text{Hz}$
 - Between 42.5 and 57.5Hz ($50\text{Hz} \pm 15\%$), the sampling period is locked to the network frequency. 128 samples are available for each period of the network.
 - Outside of the 51–69Hz band, the sampling period is $128 \times 50\text{ Hz}$.
- Network frequency $f = 60\text{ Hz}$
 - Between 51 and 69 Hz ($60\text{ Hz} \pm 15\%$), the sampling period is locked to the network frequency. 128 samples are available for each period of the network.
 - Outside of the 51–69Hz band, the sampling period is $128 \times 60\text{Hz}$.
- Network frequency $f = 400\text{ Hz}$
 - Between 340 and 460 Hz ($400\text{ Hz} \pm 15\%$), the sampling period is locked to the network frequency. 16 samples are available for each period of the network.
 - Outside of the 340–460Hz band, the sampling period is $16 \times 400\text{Hz}$.

A DC signal is treated as outside of the frequency ranges. The sampling frequency is then, depending on the preset network frequency, 6.4 kHz ($50/400\text{Hz}$) or 7.68 kHz (60Hz).

9.1.2.2. Locking of the sampling frequency

- As default, the sampling frequency is locked to V1.
- If V1 is missing, the instrument attempts to lock to V2, then to V3, I1, I2, and I3.

9.1.2.3. AC/DC

The PEL makes AC and DC measurements for AC and DC distribution networks. AC or DC is selected by the user.

The AC + DC values are available with PEL Transfer.

9.1.2.4. Neutral current measurement

Depending on the distribution network, if there is no current sensor on the I_N terminal, the neutral current is determined by calculation.

9.1.2.5. "200ms" quantities

The instrument calculates the following quantities every 200 ms on the basis of measurements on 10 periods for 50Hz, 12 periods for 60Hz, and 80 periods for 400Hz, as indicated by Table 22.

The "200ms" quantities are used for:

- the trends on the "1s" quantities
- the aggregation of the values for the "1s" quantities (See § 9.1.2.6).

All of the "200ms" quantities can be recorded on the SD card during the recording session.

9.1.2.6. "1 s" quantities (one second)

The instrument calculates the following quantities every 200 ms on the basis of measurements on 50 periods for 50Hz, 60 periods for 60Hz, and 400 periods for 400Hz, as indicated by Table 22.

The "1s" quantities are used for:

- the real-time values
- the trends
- the aggregation of the values for the "aggregated" quantities (See § 9.1.2.7).
- the determination of the values and maximum/minimum for the values of the "aggregated" trends

All of the "1s" quantities can be recorded on the SD card during the recording session.

9.1.2.7. Aggregation

An aggregated quantity is a value calculated over an aggregation period as indicated by Table 23.

The aggregation period always starts at the beginning of an hour or of a minute. The aggregation period is the same for all quantities. The possible periods are the following: 1, 2, 3, 4, 5, 6, 10, 12, 15, 20, 30 and 60 min.

All aggregated quantities are recorded on the SD card during the recording session. They can be displayed in PEL Transfer (See § 5).

9.1.2.8. Minimum and maximum

The Min and Max are the minimum and maximum values observed during the aggregation period considered. They are recorded with their dates and times (see Table 23). The Max of some aggregated values are displayed directly on the instrument.

9.1.2.9. Energy calculations

The energies are calculated every second.

The total energy is the demand during the recording session.

The partial energy can be determined for one of the following integration periods: 1h, 1 day, 1 week or 1 month. The partial energy index is available only in real time. It is not recorded.

On the other hand, the total energies are available with the data of the recorded session.

9.2. MEASUREMENT FORMULAS

Most of the formulas are taken from standard IEEE 1459.

The PEL measures or calculates the values below for one cycle (128 samples per period from 16 to 400Hz. These values are not accessible to the user.

The PEL then calculates a value aggregated over 10 cycles (50Hz), 12 cycles (60Hz), or 80 cycles (400Hz) ("200ms" quantities), then 50 cycles (50Hz), 60 cycles (60Hz), or 400 cycles (400Hz) ("1s" quantities).

Quantities	Formulas	Remarks
AC measurements		
Crest factor in AC voltage (V_{L-CF})	$V_{L-CF}[T] = \frac{1}{n} \times \sum_{x=1}^n \frac{V_{L-peak_x}}{V_L}$	L = 1, 2 or 3
AC inverse voltage unbalance (u_2)	$u_2 = 100 \times \frac{V^-}{V^+}$	*
AC homopolar voltage unbalance (u_0)	$u_0 = 100 \times \frac{V^0}{V^+}$	*
Crest factor of the current (I_{L-CF})	$I_{L-CF}[T] = \frac{1}{n} \times \sum_{x=1}^n \frac{I_{L-peak_x}}{I_L}$	L = 1, 2 or 3
AC inverse current unbalance (i_2)	$i_2 = 100 \times \frac{I^-}{I^+}$	*
AC homopolar current unbalance (i_0)	$i_0 = 100 \times \frac{I^0}{I^+}$	*
AC reactive power (Q_L)	$Q_L = V_{L-H1} \times I_{L-H1} \times \sin \varphi(I_{L-H1}, V_{L-H1})$ $Q_T = Q_1 + Q_2 + Q_3$	L = 1, 2 or 3
AC apparent power (S_L)	$S_L = V_L \times I_L$ $S_T = S_1 + S_2 + S_3$	L = 1, 2 or 3
Fundamental angles $\varphi(I_L, V_L)$ $\varphi(I_L, I_M)$ $\varphi(I_M, V_M)$	FFT calculation	φ is the phase difference between the fundamental current I_L and the fundamental voltage V_L
AC non-active power (N_L)	$N_L = \sqrt{S_L^2 - P_L^2}$	L = 1, 2, 3 or T
AC distortion power (D_L)	$D_L = \sqrt{N_L^2 - Q_L^2}$	L = 1, 2, 3 or T
Quadrant (q)	The quadrants are defined as follows: <ul style="list-style-type: none"> ■ when $Pf_L[10/12] > 0$ and $Q_L[10/12] > 0$: quadrant 1 ■ when $Pf_L[10/12] < 0$ and $Q_L[10/12] > 0$: quadrant 2 ■ when $Pf_L[10/12] < 0$ and $Q_L[10/12] < 0$: quadrant 3 ■ when $Pf_L[10/12] > 0$ and $Q_L[10/12] < 0$: quadrant 4 	
AC fundamental active power (Pf_L)	$Pf_L = V_{L-H1} \times I_{L-H1} \times \cos \varphi(I_{L-H1}, V_{L-H1})$ $Pf_T = Pf_1 + Pf_2 + Pf_3$	L = 1, 2 or 3
AC fundamental direct active power (P^+)	$P^+ = 3 \times V^+ \times I^+ \times \cos \theta(I^+, V^+)$	

Quantities	Formulas	Remarks
AC fundamental apparent power (S_{f_L})	$S_{f_L} = V_{L-H1} \times I_{L-H1}$ $S_{f_T} = S_{f_1} + S_{f_2} + S_{f_3}$	L = 1, 2 or 3
AC power factor (PF_L)	$PF_L = \frac{P_L}{S_L}$	L = 1, 2 or 3
AC active power unbalance (P_U)	$P_U = Pf_T - P^+$	
AC harmonic active powers (P_H)	$P_H = P_T - Pf_T$	
DPF _L / Cos φ_L AC	$DPF_L = \cos \varphi_L = \cos \varphi (I_{L-H1}, V_{L-H1})$ $\cos \varphi_T = \frac{Pf_T}{S_{f_T}}$	L = 1, 2 or 3
Tan Φ AC	$Tan\Phi = \frac{Q_T}{P_T}$	
DC measurements		
DC voltage (V_{Ldc})	$V_{Ldc} [T] = \frac{1}{n} \times \sum_{x=1}^n V_{Ldc.x}$	L = 1, 2, 3 or E
DC current (I_{Ldc})	$I_{Ldc} [T] = \frac{1}{n} \times \sum_{x=1}^n I_{Ldc.x}$ When there is no current sensor on I_N , I_N is calculated: $I_{Ndc} = I_{1dc} + I_{2dc} + I_{3dc}$	L = 1, 2, 3 or N
Energy measurements		
AC consumed active energy (E_{p+})	$E_{p+} = \sum P_{T+x}$	
AC generated active energy (E_{p-})	$E_{p-} = (-1) \times \sum P_{T-x}$	
AC reactive energy in quadrant 1 (E_{Q1})	$E_{Q1} = \sum Q_{Tq1x}$	
AC reactive energy in quadrant 2 (E_{Q2})	$E_{Q2} = \sum Q_{Tq2x}$	
AC reactive energy in quadrant 3 (E_{Q3})	$E_{Q3} = (-1) \times \sum Q_{Tq3x}$	
AC reactive energy in quadrant 4 (E_{Q4})	$E_{Q4} = (-1) \times \sum Q_{Tq4x}$	
AC consumed apparent energy (E_{S+})	$E_{S+} = \sum S_{T+x}$	
AC generated apparent energy (E_{S-})	$E_{S-} = \sum S_{T-x}$	
DC consumed energy (E_{Pdc+})	$E_{Pdc+} = \sum P_{Tdc+x}$	
DC consumed energy (E_{Pdc-})	$E_{Pdc-} = (-1) \times \sum P_{Tdc-x}$	

Table 22

T is the period

n is the number of samples.

*: The direct, inverse, and homopolar voltages and currents (V^+ , I^+ , V^- , I^- , V^0 , I^0) are calculated using the Fortescue transform.

V_1 , V_2 , V_3 are the phase-neutral voltages of the installation measured. [$V_1=V_{L1-N}$; $V_2=V_{L2-N}$; $V_3=V_{L3-N}$].

The lower-case v_1 , v_2 , v_3 designate the sampled values.

U_1 , U_2 , U_3 are the voltages between phases of the installation measured.

Lower-case designates the sampled values [$u_{12} = v_1-v_2$; $u_{23} = v_2-v_3$; $u_{31} = v_3-v_1$].

I₁, I₂, I₃ are the currents flowing in the phase conductors of the installation measured.

I_N is the current flowing in the neutral conductor of the installation measured.

The lower-case i₁, i₂, i₃ designate the sampled values.

For some quantities linked to the powers, the "generated" and "consumed" quantities are counted separately for the values aggregated from the "1s" values.

Quantities	Formulas	Remarks
AC measurements		
AC consumed active power (P _{L+})	$P_{L+} = \frac{1}{n} \times \sum_{x=1}^n P_{L+x}$	L = 1, 2, 3 or T
AC generated active power (P _{L-})	$P_{L-} = (-1) \times \frac{1}{n} \times \sum_{x=1}^n P_{L-x}$	P _{L-} > 0 L = 1, 2, 3 or T
AC consumed reactive power (Q _{L+})	$Q_{L+} = \frac{1}{n} \times \sum_{x=1}^n Q_{L+x}$	Q _{L+} can be > 0 or < 0 Q _{L+} [agg] = Q _{L1} [agg] - Q _{L4} [agg] L = 1, 2, 3 or T
AC generated active power (Q _{L-})	$Q_{L-} = (-1) \times \frac{1}{n} \times \sum_{x=1}^n Q_{L-x}$	Q _{L-} can be > 0 or < 0 Q _{L-} [agg] = -Q _{L2} [agg] + Q _{L3} [agg] L = 1, 2, 3 or T
AC consumed apparent power (S _{L+})	$S_{L+} = \frac{1}{n} \times \sum_{x=1}^n S_{L+x}$	S _{L+} is used for the calculation PF _{L+} and of E _{L+} . L = 1, 2, 3 or T
AC generated apparent power (S _{L-})	$S_{L-} = \frac{1}{n} \times \sum_{x=1}^n S_{L-x}$	S _{L-} is used for the calculation PF _{L-} and of E _{L-} . L = 1, 2, 3 or T
AC consumed fundamental active power (Pf _{L+})	$Pf_{L+} = \frac{1}{n} \times \sum_{x=1}^n Pf_{L+x}$ $Pf_{T+} = Pf_{1+} + Pf_{2+} + Pf_{3+}$	L = 1, 2 or 3
AC generated fundamental active power (Pf _{L-})	$Pf_{L-} = \frac{1}{n} \times \sum_{x=1}^n Pf_{L-x}$	L = 1, 2, 3 or T
AC consumed fundamental apparent power (Sf _{L+})	$Sf_{L+} = \frac{1}{n} \times \sum_{x=1}^n Sf_{L+x}$	L = 1, 2, 3 or T
AC generated fundamental apparent power (Sf _{L-})	$Sf_{L-} = \frac{1}{n} \times \sum_{x=1}^n Sf_{L-x}$ $Sf_{T-} = Sf_{1-} + Sf_{2-} + Sf_{3-}$	L = 1, 2 or 3
AC consumed power factor (PF _{L+})	$PF_{L+} = \frac{P_{L+}}{S_{L+}}$	L = 1, 2, 3 or T
AC generated power factor (PF _{L-})	$PF_{L-} = \frac{P_{L-}}{S_{L-}}$	PF _{L-} > 0 L = 1, 2, 3 or T
Cos φ _L AC consumed (Cos φ _{L+})	$Cos \varphi_{L+} = \frac{Pf_{L+}}{Sf_{L+}}$	L = 1, 2, 3 or T
Cos φ _L AC on the source (Cos φ _{L-})	$Cos \varphi_{L-} = \frac{Pf_{L-}}{Sf_{L-}}$	Cos φ _{L-} > 0 L = 1, 2, 3 or T
Tan Φ AC on the load (Φ ₊)	$Tan \Phi_{+} = \frac{Q_{T+}}{P_{T+}}$	

Quantities	Formulas	Remarks
AC generated Tan Φ (Φ_-)	$\text{Tan}\Phi_- = \frac{Q_{T-}}{P_{T-}}$	
DC measurements		
DC consumed active power (P_{L+dc})	$P_{L+d.c.} = \frac{1}{n} \times \sum_{x=1}^n P_{L+d.c.x}$	L = 1, 2, 3 or T
DC generated active power (P_{L-dc})	$P_{L-d.c.} = (-1) \times \frac{1}{n} \times \sum_{x=1}^n P_{L-d.c.x}$	L = 1, 2, 3 or T
AC+DC measurements		
AC+DC consumed active power ($P_{L+ac+dc}$)	$P_{L+a.c.+d.c.} = P_{L+} + P_{L+d.c.}$	L = 1, 2, 3 or T
AC+DC generated active power ($P_{L-ac+dc}$)	$P_{L-a.c.+d.c.} = P_{L-} + P_{L-d.c.}$	L = 1, 2, 3 or T
AC+DC consumed apparent power ($S_{L+ac+dc}$)	$S_{L+a.c.+d.c.} = \frac{1}{n} \times \sum_{x=1}^n S_{L+a.c.+d.c.x}$	L = 1, 2, 3 or T
AC+DC generated apparent power ($S_{L-ac+dc}$)	$S_{L-a.c.+d.c.} = \frac{1}{n} \times \sum_{x=1}^n S_{L-a.c.+d.c.x}$	L = 1, 2, 3 or T

Table 23

+ = load
 - = source
 q = quadrant = 1, 2, 3 or 4

9.3. ELECTRICAL NETWORKS ALLOWED

The following types of distribution network are managed:

Distribution network	Abbreviation	Phase order	Remarks	Reference diagram
Single-phase (single-phase 2-wire)	1P-2W	No	The voltage is measured between L1 and N. The current is measured on the L1 conductor.	See § 4.1.1.
Two-phase (split-phase single-phase 3-wire)	1P-3W	No	The voltage is measured between L1, L2 and N. The current is measured on the L1 and L2 conductors. The neutral current is measured or calculated: $i_N = i_1 + i_2$	See § 4.1.2.
Three-phase, 3-wire Δ [2 current sensors]	3P-3W Δ 2	Yes	The power measurement method is based on the two-wattmeter method with a virtual neutral. The voltage is measured between L1, L2 and L3. The current is measured on the L1 and L3 conductors. The current i_2 is calculated (no current sensor on L2): $i_2 = -i_1 - i_3$ The neutral is not available for the measurement of the current and of the voltage	See § 4.1.3.1.
Three-phase, 3-wire open Δ (2 current sensors)	3P-3WO2			See § 4.1.3.3.
Three-phase 3-wire wye [2 current sensors]	3P-3WY2			See § 4.1.3.5.

Distribution network	Abbreviation	Phase order	Remarks	Reference diagram
Three-phase, 3-wire Δ (3 current sensors)	3P-3W Δ 3	Yes	The power measurement is based on the three-wattmeter method with a virtual neutral. The voltage is measured between L1, L2 and L3. The current is measured on the L1, L2 and L3 conductors. The neutral is not available for the measurement of the current and of the voltage	See § 4.1.3.2.
Three-phase, 3-wire open Δ (3 current sensors)	3P-3WO3			See § 4.1.3.4.
Three-phase, 3-wire, wye [3 current sensors]	3P-3WY3			See § 4.1.3.6.
Three-phase, 3-wire Δ , balanced	3P-3W Δ B	No	The power measurement is based on the one-wattmeter method. The voltage is measured between L1 and L2. The current is measured on the L3 conductor. $U_{23} = U_{31} = U_{12}$. $I_1 = I_2 = I_3$	See § 4.1.3.7.
Three-phase 4-wire wye	3P-4WY	Yes	The power measurement is based on the three-wattmeter method with neutral. The voltage is measured between L1, L2 and L3. The current is measured on the L1, L2 and L3 conductors. The neutral current is measured or calculated: $i_N = i_1 + i_2 + i_3$.	See § 4.1.4.1.
Three-phase, 4-wire, wye, balanced	3P-4WYB	No	The power measurement is based on the one-wattmeter method. The voltage is measured between L1 and N. The current is measured on the L1 conductor. $V_1 = V_2 = V_3$ $U_{23} = U_{31} = U_{12} = V_1 \times \sqrt{3}$. $I_1 = I_2 = I_3$ $I_N = 3 \times I_1$	See § 4.1.4.2.
Three-phase, 3-wire, wye $2\frac{1}{2}$	3P-4WY2	Yes	This method is called the $2\frac{1}{2}$ -element method The power measurement is based on the three-wattmeter method with a virtual neutral. The voltage is measured between L1, L3 and N. V2 is calculated: $v_2 = -v_1 - v_3$, $u_{12} = 2v_1 + v_3$, $u_{23} = -v_1 - 2v_3$. V ₂ is assumed to be balanced. The current is measured on the L1, L2 and L3 conductors. The neutral current is measured or calculated: $i_N = i_1 + i_2 + i_3$.	See § 4.1.4.3.
Three-phase, 4-wire Δ	3P-4W Δ	No	The power measurement is based on the three-wattmeter method with neutral, but no power information is available for the individual phases. The voltage is measured between L1, L2 and L3. The current is measured on the L1, L2 and L3 conductors. The neutral current is measured or calculated for only one branch of the transformer: $i_N = i_1 + i_2 + i_3$.	See § 4.1.5.1.
Three-phase, 4-wire, open Δ	3P-4WO			See § 4.1.5.2.
DC 2-wire	DC-2W	No	The voltage is measured between L1 and N. The current is measured on the L1 conductor.	See § 4.1.6.1.
DC 3-wire	DC-3W	No	The voltage is measured between L1, L2 and N. The current is measured on the L1 and L2 conductors. The negative (return) current is measured or calculated: $i_N = i_1 + i_2$.	See § 4.1.6.2.
DC 4-wire	DC-4W	No	The voltage is measured between L1, L2, L3 and N. The current is measured on the L1, L2 and L3 conductors. The negative (return) current is measured or calculated: $i_N = i_1 + i_2 + i_3$.	See § 4.1.6.3.

Table 24

9.4. QUANTITY ACCORDING TO THE DISTRIBUTION NETWORK

= Yes = No

Quantities		1P-2W	1P-3W	3P-3W Δ 2 3P-3W Δ 3 3P-3W Δ B	3P-3W Δ 2 3P-3W Δ 3 3P-3W Δ B	3P-3W Δ B	3P-4WY	3P-4WYB	3P-4WY2	3P-4W Δ 3P-4W Δ O	DC-2W	DC-3W	DC-4W
V_1	AC RMS	•	•				•	•	•	•			
V_2	AC RMS		•				•	• = V_1	•(10)	•			
V_3	AC RMS						•	• = V_1	•	•			
V_{NE}	AC RMS	•	•				•	•	•	•			
V_1	DC										•	•	•
V_2	DC											•	•
V_3	DC												•
V_{NE}	DC	•	•				•	•	•	•	•	•	•
V_1	AC + DC RMS	•	•				•	•	•	•			
V_2	AC + DC RMS		•				•	•(1)	•(10)	•			
V_3	AC + DC RMS						•	•(1)	•	•			
V_{NE}	AC + DC RMS	•	•				•	•	•	•			
U_{12}	AC RMS		•	•	•	•	•	•(1)	•(10)	•			
U_{23}	AC RMS			•	•	•(1)	•	•(1)	•(10)	•			
U_{31}	AC RMS			•	•	•(1)	•	•(1)	•	•			
I_1	AC RMS	•	•	•	•	•	•	•	•	•			
I_2	AC RMS		•	•(2)	•	•(1)	•	•(1)	•	•			
I_3	AC RMS			•	•	•(1)	•	•(1)	•	•			
I_N	AC RMS		•				•	•	•	•			
I_1	DC										•	•	•
I_2	DC											•	•
I_3	DC												•
I_N	DC											•	•
I_1	AC + DC RMS	•	•	•	•	•(1)	•	•	•	•			
I_2	AC + DC RMS		•	•(2)	•	•(1)	•	•(1)	•	•			
I_3	AC + DC RMS			•	•	•	•	•(1)	•	•			
I_N	AC + DC RMS		•				•	•	•	•			
V_{1-CF}		•	•				•	•	•	•			
V_{2-CF}			•				•	•(1)	•(10)	•			
V_{3-CF}							•	•(1)	•	•			
I_{1-CF}		•	•	•	•	•	•	•	•	•			
I_{2-CF}			•	•(2)	•	•(1)	•	•(1)	•	•			
I_{3-CF}				•	•	•(1)	•	•(1)	•	•			
V_+				•	•	•	•	•	•(10)				
V_-				•	•	•(4)	•	•(4)	•(10)				
V_0				•	•	•(4)	•	•(4)	•(10)				
I_+				•	•	•	•	•	•				

Quantities		1P-2W	1P-3W	3P-3W Δ 2 3P-3WO2 3P-3WY2	3P-3W Δ 3 3P-3WO3 3P-3WY3	3P-3W Δ B	3P-4WY	3P-4WYB	3P-4WY2	3P-4W Δ 3P-4WO	DC-2W	DC-3W	DC-4W
I_1				•	•	•(4)	•	•(4)	•				
I_0				•	•	•(4)	•	•(4)	•				
u_0				•	•	•(4)	•	•(4)	•(4)	•(3)			
u_2				•	•	•(4)	•	•(4)	•(4)	•(3)			
i_0				•	•	•(4)	•	•(4)	•	•(3)			
i_2				•	•	•(4)	•	•(4)	•	•(3)			
F		•	•	•	•	•	•	•	•	•			
P_1	AC	•	•				•	•	•	•			
P_2	AC		•				•	•(1)	•(10)	•			
P_3	AC						•	•(1)	•	•			
P_T	AC	•(7)	•	•	•	•	•	•(1)	•	•			
P_1	DC										•	•	•
P_2	DC											•	•
P_3	DC												•
P_T	DC										•(7)	•	•
P_1	AC+DC	•	•				•	•	•	•			
P_2	AC+DC		•				•	•(1)	•(10)	•			
P_3	AC+DC						•	•(1)	•	•			
P_T	AC+DC	•(7)	•	•	•	•	•	•(1)	•	•			
Pf_1		•	•				•	•	•	•			
Pf_2			•				•	•(1)	•(10)	•			
Pf_3							•	•(1)	•	•			
Pf_T		•(7)	•	•	•	•	•	•(1)	•	•			
P_+				•	•	•	•	•(1)	•				
P_U				•	•	•(4)	•	•(4)	•				
P_h		•	•	•	•	•	•	•	•				
Q_1		•	•				•	•	•	•			
Q_2			•				•	•(1)	•(10)	•			
Q_3							•	•(1)	•	•			
Q_T		•(7)	•	•	•	•	•	•(1)	•	•			
S_1	AC	•	•				•	•	•	•			
S_2	AC		•				•	•(1)	•(10)	•			
S_3	AC						•	•(1)	•	•			
S_T	AC	•(7)	•	•	•	•	•	•(1)	•	•			
S_1	AC+DC	•	•				•	•	•	•			
S_2	AC+DC		•				•	•(1)	•(10)	•			
S_3	AC+DC						•	•(1)	•	•			
S_T	AC+DC	•(7)	•	•	•	•	•	•(1)	•	•			
Sf_1		•	•				•	•	•	•			
Sf_2			•				•	•(1)	•(10)	•			
Sf_3							•	•(1)	•	•			
Sf_T		•(7)	•	•	•	•	•	•(1)	•	•			
N_1	AC	•	•				•	•	•	•			
N_2	AC		•				•	•(1)	•(10)	•			
N_3	AC						•	•(1)	•	•			
N_T	AC	•(7)	•	•	•	•	•	•(1)	•	•			
N_1	AC+DC	•	•				•	•	•	•			
N_2	AC+DC		•				•	•(1)	•(10)	•			

Quantities		1P-2W	1P-3W	3P-3W Δ 2 3P-3WO2 3P-3WY2	3P-3W Δ 3 3P-3WO3 3P-3WY3	3P-3W Δ B	3P-4WY	3P-4WYB	3P-4WY2	3P-4W Δ 3P-4WO	DC-2W	DC-3W	DC-4W	
N_3	AC+DC						•	•(1)	•	•				
N_T	AC+DC	•(7)	•	•	•	•	•	•(1)	•	•				
D_1	AC	•	•				•	•	•	•				
D_2	AC		•				•	•(1)	•(10)	•				
D_3	AC						•	•(1)	•	•				
D_T	AC	•(7)	•	•	•	•	•	•(1)	•	•				
D_1	AC+DC	•	•				•	•	•	•				
D_2	AC+DC		•				•	•(1)	•(10)	•				
D_3	AC+DC						•	•(1)	•	•				
D_T	AC+DC	•(7)	•	•	•	•	•	•(1)	•	•				
PF_1		•	•				•	•	•	•				
PF_2			•				•	•(1)	•(10)	•				
PF_3							•	•(1)	•	•				
PF_T		•(7)	•	•	•	•	•	•(1)	•	•				
$\text{Cos } \varphi_1$		•	•				•	•	•	•				
$\text{Cos } \varphi_2$			•				•	•(1)	•(10)	•				
$\text{Cos } \varphi_3$							•	•(1)	•	•				
$\text{Cos } \varphi_T$		•(7)	•	•	•	•	•	•(1)	•	•				
$\text{Tan } \Phi$		•	•	•	•	•(3)	•	•	•(10)	•				
$V_1\text{-Hi}$	i=1 at 50 (6) %f	•	•				•	•	•	•				
$V_2\text{-Hi}$			•				•	•(1)	•(10)	•				
$V_3\text{-Hi}$								•	•(1)	•	•			
$U_{12}\text{-Hi}$	i=1 at 50 (6) %f		•	•	•	•	•	•(1)	•(10)	•				
$U_{23}\text{-Hi}$				•	•	•(1)	•	•(1)	•(10)	•				
$U_{31}\text{-Hi}$					•	•	•(1)	•	•(1)	•	•			
$I_1\text{-Hi}$	i=1 at 50 (6) %f	•	•	•	•	•	•	•	•	•				
$I_2\text{-Hi}$				•	•(2)	•	•(1)	•	•(1)	•	•			
$I_3\text{-Hi}$					•	•	•(1)	•	•(1)	•	•			
$I_N\text{-Hi}$				•(2)				•(2)	•(4)	•(2)	•(2)			
$V_1\text{-THD}$	%f	•	•				•	•	•	•				
$V_2\text{-THD}$	%f		•				•	•(1)	•(10)	•				
$V_3\text{-THD}$	%f						•	•(1)	•	•				
$U_{12}\text{-THD}$	%f		•	•	•	•	•	•(1)	•	•				
$U_{23}\text{-THD}$	%f			•	•	•(1)	•	•(1)	•	•				
$U_{31}\text{-THD}$	%f			•	•	•(1)	•	•(1)	•	•				
$I_1\text{-THD}$	%f	•	•	•	•	•	•	•	•	•				
$I_2\text{-THD}$	%f		•	•(2)	•	•(1)	•	•(1)	•	•				
$I_3\text{-THD}$	%f			•	•	•(1)	•	•(1)	•	•				
$I_N\text{-THD}$	%f		•(2)				•(2)	•(4)	•(2)	•(2)				
Phase order	I			•	•	•	•		•	•				
	V			•	•	•	•		•	•				
	I, V	•	•	•	•	•	•	•	•	•				
$\varphi(V_2, V_1)$			•				•	•(9)						
$\varphi(V_3, V_2)$							•	•(9)						
$\varphi(V_1, V_3)$							•	•(9)	•	•				
$\varphi(V_{23}, V_{12})$				•	•	•(9)	•	•(9)		•				
$\varphi(V_{12}, V_{31})$				•	•	•(9)	•	•(9)		•				
$\varphi(V_{31}, V_{23})$				•	•	•(9)	•	•(9)		•				

Quantities		1P-2W	1P-3W	3P-3W Δ 2 3P-3WO2 3P-3WY2	3P-3W Δ 3 3P-3WO3 3P-3WY3	3P-3W Δ B	3P-4WY	3P-4WYB	3P-4WY2	3P-4W Δ 3P-4WO	DC-2W	DC-3W	DC-4W
$\varphi(V_2, V_1)$			•		•	•(9)	•	•(9)	•	•			
$\varphi(V_3, V_2)$					•	•(9)	•	•(9)	•	•			
$\varphi(V_1, V_3)$				•	•	•(9)	•	•(9)	•	•			
$\varphi(V_1, V_1)$		•	•			•(8)	•	•	•	•			
$\varphi(V_2, V_2)$			•				•	•					
$\varphi(V_3, V_3)$							•	•	•	•			
E_{PT}	Source AC	•	•	•	•	•	•	•	•	•	•(5)	•(5)	•(5)
E_{PT}	Load AC	•	•	•	•	•	•	•	•	•	•(5)	•(5)	•(5)
E_{QT}	Quad 1	•	•	•	•	•	•	•	•	•	•(5)	•(5)	•(5)
E_{QT}	Quad 2	•	•	•	•	•	•	•	•	•	•(5)	•(5)	•(5)
E_{QT}	Quad 3	•	•	•	•	•	•	•	•	•	•(5)	•(5)	•(5)
E_{QT}	Quad 4	•	•	•	•	•	•	•	•	•	•(5)	•(5)	•(5)
E_{ST}	Source	•	•	•	•	•	•	•	•	•	•(5)	•(5)	•(5)
E_{ST}	Load	•	•	•	•	•	•	•	•	•	•(5)	•(5)	•(5)
E_{PT}	Source DC	•(5)	•(5)	•(5)	•(5)	•(5)	•(5)	•(5)	•(5)	•(5)	•	•	•
E_{PT}	Load DC	•(5)	•(5)	•(5)	•(5)	•(5)	•(5)	•(5)	•(5)	•(5)	•	•	•

Table 25

(1) Extrapolated

(2) Calculated

(3) Value not significant

(4) Always = 0

(5) AC+DC when selected

(6) 7th max at 400Hz

(7) $P_1 = P_T$, $\varphi_1 = \varphi_T$, $S_1 = S_T$, $PF_1 = PF_T$, $\cos \varphi_1 = \cos \varphi_T$, $Q_1 = Q_T$, $N_1 = N_T$, $D_1 = D_T$

(8) $\varphi(I_3, U_{12})$

(9) Always = 120°

(10) Interpolated

9.5. GLOSSARY

φ	Phase shift of the phase-neutral voltage with respect to the phase-neutral current.
$\overset{\curvearrowright}{\perp}$	Inductive phase shift.
$\overset{\curvearrowleft}{\perp}$	Capacitive phase shift.
°	Degree.
%	Percentage.
A	Ampere (unit of current).
AC	AC component (current or voltage).
Aggregation	Various means defined in § 9.2.
APN	Access Point Name. This depends on your Internet access provider.
CF	Crest factor of the current or voltage: ratio of the crest (peak) value of a signal to the RMS value.
$\cos \varphi$	Cosine of the phase shift of the phase-neutral voltage with respect to the phase-neutral current.
D	Distortion power.
DC	DC component (current or voltage).
Ep	Active energy.
Eq	Reactive energy.
Es	Apparent energy.
f (Frequency)	Number of complete periods of voltage or current per second.
Fundamental component:	component at the fundamental frequency.
Harmonics	In electrical systems, voltages and currents at multiples of the fundamental frequency.
Hz	Hertz (unit of frequency).
I	Symbol of the current.
I-CF	Crest factor of the current.

I-THD	Total harmonic distortion of the current.
I_L	RMS current (L = 1, 2 or 3)
I_{L-Hn}	Value or percentage of current of the n th harmonic (L = 1, 2 or 3).
IRD Server (DataViewSync™)	Internet Relay Device server. Server used to relay data between the logger and a PC.
L	Phase of a polyphase electrical network.
MAX	Maximum value.
Measurement method	Any measurement method associated with an individual measurement.
MIN	Minimum value.
N	Non-active power.
Nominal voltage	Nominal voltage of a network.
Order of a harmonic	ratio of the frequency of the harmonic to the fundamental frequency; a whole number.
P	Active power.
PF	Power Factor - ratio of the active power to the apparent power.
Phase	Time relation between current and voltage in AC circuits.
Q	Reactive power.
RMS	Root Mean Square of the current or voltage. Square root of the mean of the squares of the instantaneous values of a quantity during a specified interval.
S	Apparent power.
tan Φ	Ratio of the reactive power to the active power.
THD	Total Harmonic Distortion. This characterizes the proportion of harmonics of a signal with respect to the RMS value of the fundamental component or the total RMS value without the DC component.
U	Voltage between two phases.
U-CF	Crest factor of the phase-phase voltage.
u2	Unbalance of the phase-neutral voltages.
U_{L-Hn}	Value or percentage of phase-phase voltage of the n th harmonic (L = 1, 2 or 3)
Unbalance of the voltages of a polyphase network	State in which the RMS voltages between conductors (fundamental component) and/or the phase differences between successive conductors are not equal.
Uxy-THD	Total harmonic distortion of the voltage between two phases.
V	Phase-neutral voltage or Volt (unit of voltage).
V-CF	Crest factor of the voltage
V-THD	Total harmonic distortion of the phase-neutral voltage.
VA	Unit of apparent power (Volt x Ampere).
var	Unit of reactive power.
varh	Unit of reactive energy.
V_L	RMS voltage (L = 1, 2, or 3)
V_{L-Hn}	Value or percentage of phase-neutral voltage of the n th harmonic (L = 1, 2 or 3).
W	Unit of active power (Watt).
Wh	Unit of active energy (Watt x hour).

Prefixes of the units of the international system (SI)

Prefix	Symbol	Multiplies by
milli	m	10 ⁻³
kilo	k	10 ³
Mega	M	10 ⁶
Giga	G	10 ⁹
Tera	T	10 ¹²
Peta	P	10 ¹⁵
Exa	E	10 ¹⁸

Table 26



FRANCE

Chauvin Arnoux

12-16 rue Sarah Bernhardt

92600 Asnières-sur-Seine

Tél : +33 1 44 85 44 85

Fax : +33 1 46 27 73 89

info@chauvin-arnoux.com

www.chauvin-arnoux.com

INTERNATIONAL

Chauvin Arnoux

Tél : +33 1 44 85 44 38

Fax : +33 1 46 27 95 69

Our international contacts

www.chauvin-arnoux.com/contacts

